

SKF

SKF precision bearings



Contents

Made by SKF® stands for excellence. It symbolises our consistent endeavour to achieve total quality in everything we do. For those who use our products, “Made by SKF” implies three main benefits.

Reliability – thanks to modern, efficient products, based on our worldwide application know-how, optimised materials, forward-looking designs and the most advanced production techniques.

Cost effectiveness – resulting from the favourable ratio between our product quality plus service facilities, and the purchase price of the product.

Market lead – which you can achieve by taking advantage of our products and services. Increased operating time and reduced down-time, as well as improved output and product quality are the key to a successful partnership.



A precision bearing range to meet all needs 3

Selection of bearing type 4

1 Angular contact ball bearings 9

General information 9

Precision angular contact ball bearings 16

Hybrid precision angular contact ball bearings 28

2 Cylindrical roller bearings 37

General information 37

Double row cylindrical roller bearings 40

Single row cylindrical roller bearings 46

3 Single direction angular contact thrust ball bearings 49

General information 49

Single direction angular contact thrust ball bearings .. 52

4 Double direction angular contact thrust ball bearings 55

General information 55

Double direction angular contact thrust ball bearings 58

5 Gauges 63

Ring gauges 64

Internal clearance gauges 65

6 Tolerances 66

P4A for radial angular contact ball bearings 67

PA9A for radial angular contact ball bearings 68

SP for radial cylindrical roller bearings 69

UP for radial cylindrical roller bearings 70

P4/P2 for angular contact thrust ball bearings 72

P4C for angular contact thrust ball bearings 72

SP for angular contact thrust ball bearings 73

UP for angular contact thrust ball bearings 73

The SKF Group – a worldwide organisation 74

A precision bearing range to meet all needs

It is not always possible to satisfactorily meet the demands of bearing applications using the bearings for general engineering purposes listed in the SKF General Catalogue. This is particularly true where machine tools are concerned, as the requirements placed on machine tool bearing arrangements, e.g. those of work spindles, are very demanding.

Bearings for such applications must have high running accuracy and high stiffness as well as low friction if high machining accuracy is to be obtained with the lowest possible operating temperatures at high speeds and minimum temperature changes over the whole speed range.

SKF produces special precision bearings to meet these exacting demands. This brochure contains the standard range of SKF precision bearings. Of course, SKF also produces many other precision bearings, particularly in larger

sizes, and one speciality is complete spindle units, with or without integral drive.

Universal competence

As the world's leading manufacturer of ball and roller bearings, SKF not only offers a very comprehensive range of bearings, but has a wealth of experience with bearing applications of all kinds. SKF has taken the lead, for example, in defining general design principles for machine tool bearing arrangements, which have gained acceptance in the machine tool industry. SKF competence in this sector has been built up over the years in close cooperation with customers worldwide.

The more complex the technical demands, particularly in new developments, the more reason to tap the comprehensive know-how available at SKF and to recognise the competence

in the high precision bearing manufacture and application within the SKF Group.

Brief and to the point

The product tables in this brochure contain all the data required for the selection of a precision bearing and its arrangement design. A description of the particular features of the particular bearing type precedes each table section. General information regarding bearing tolerances as well as internal clearance or preload is also included.

More in-depth information on bearing technology, for example, the selection of bearing size, or lubrication, will be found in the SKF General Catalogue or in specialist handbooks and catalogues produced by SKF. The general information contained in the SKF catalogue 3700 "Precision bearings" will also be found useful.

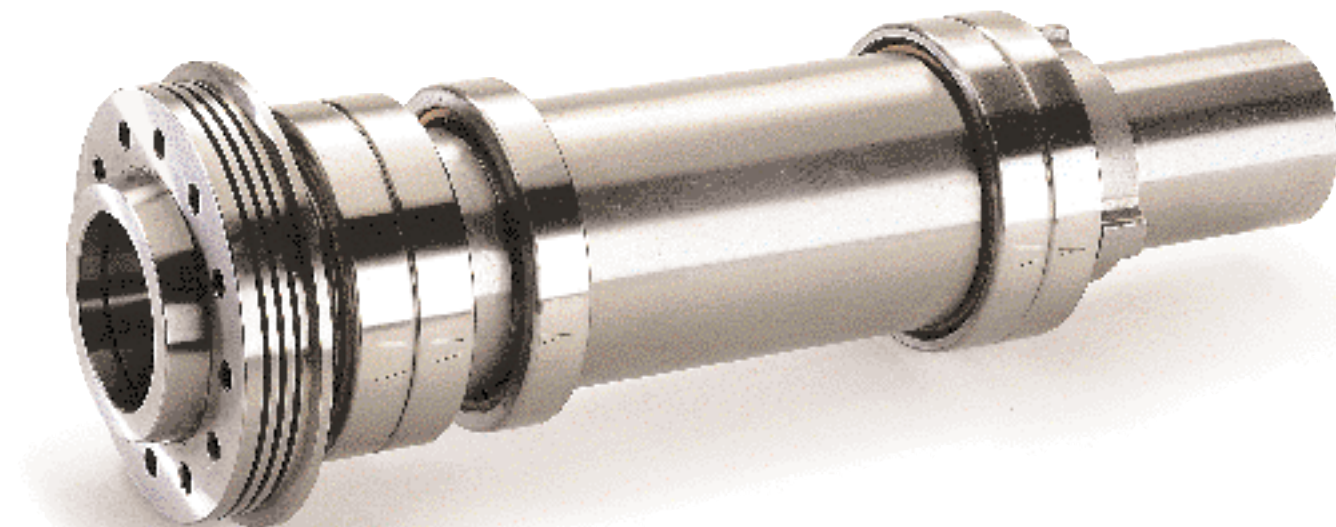

Selection of bearing type

The bearings shown in this brochure have been designed for machine tool and other applications where high demands are placed on accuracy and speed capability. Each of the bearing types has characteristic properties which make it especially suitable for particular applications.

In order to fully exploit the full potential of SKF precision bearings and to facilitate bearing selection the properties of the various types are explained. When designing a precision bearing arrangement the following factors have to be considered, for example:

- accuracy,
- available space,
- loads,
- stiffness,
- accommodation of axial displacements,
- speed, and
- heat generation.

Depending on the application, one or other of these factors will have a dominant influence. It is therefore not possible to set down general rules for the selection of bearing type or bearing series.

Accuracy

The running accuracy of a bearing arrangement is governed by the accuracy of all the component parts of the arrangement. Where the bearings are

concerned it is primarily determined by the accuracy of form and position of the raceways on the bearing rings.

When selecting the appropriate tolerance class for a particular bearing, the maximum radial runout of the inner ring (K_{ia}) is generally the determining factor for most applications.

To facilitate comparison, **Table 1** gives values of the radial runout for different tolerance classes and bearing bore diameters.

Normally, the maximum values of K_{ia} given in the table are much higher than the actual values. This means, for example, that if bearings with class SP tolerances are used, running accuracies of under $3 \mu\text{m}$ can be achieved.

Table 1

Bore diameter		Maximum radial runout (K_{ia})			
d over	incl.	Radial bearings Tolerance class			
		SP	P4A	PA9A	UP
mm		μm			
–	18	3	1,3	1,3	1,5
18	30	3	2,5	2,5	1,5
30	50	4	2,5	2,5	2
50	80	4	2,5	2,5	2
80	120	5	2,5	2,5	3
120	150	6	4	2,5	3
150	180	6	6	5	3
180	250	8	7	5	4
250	315	8	–	–	5

Maximum radial runout for different tolerance classes and bore diameters

Available space

Precision bearing arrangements generally call for bearings with a low cross section because of the limited space available and the high requirements in respect of stiffness and running accuracy of the arrangement. These bearings generally have a large number of small-diameter rolling elements and consequently have a high stiffness. They also enable relatively large diameter spindles to be used for a given housing bore diameter and therefore exhibit all the advantages which are important both for the stiffness and the running accuracy of the bearing arrangement.

Almost all the angular contact ball bearings, cylindrical roller bearings and angular contact thrust ball bearings belong to the ISO Diameter Series 9 or 0. It is thus possible, by selecting a suitable combination of bearings, to achieve an optimum bearing arrangement for particular requirements within the same radial space.

To illustrate the space requirements, the cross sections of the most common machine tool spindle bearings are shown in **fig 1**.

Loads

In machine tools, the main application for precision bearings, the load carrying capacity of a bearing is generally much less important when determining bearing size than in general engineering applications. Other criteria such as stiffness, size of the requisite bore in the spindle, machining speeds and accuracy, are the decisive factors.

When selecting the type of bearing for a given bearing arrangement, however, the magnitude as well as the direction of action of the load play an important part. As a general rule, roller bearings can carry heavier loads than ball bearings having the same envelope dimensions. Angular contact ball bearings, which have their raceways arranged at an angle to the bearing axis, are more appropriate for the accommodation of combined loads or purely axial loads.

Cross sections of the various Dimension Series of the radial and thrust bearings commonly used for machine tool spindles

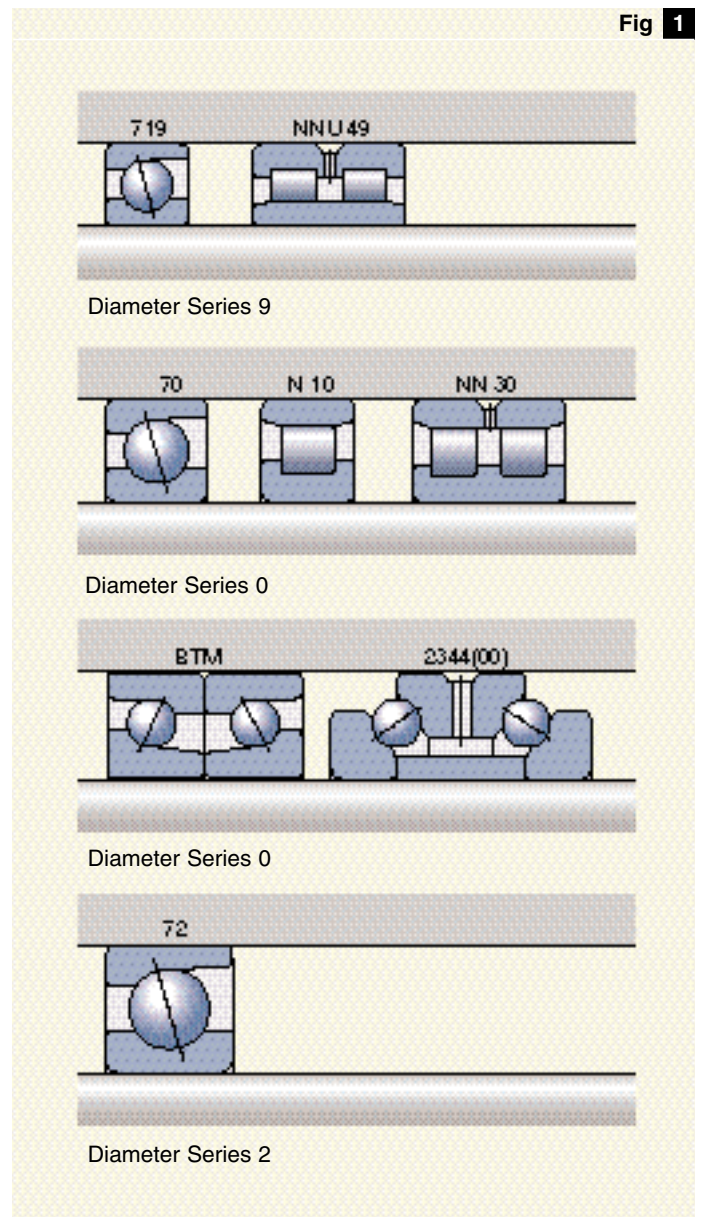

A precision bearing range to meet all needs

Stiffness

The stiffness of a bearing, characterised by the magnitude of the elastic deformation of the bearing under load, is of particular importance where highly accurate bearing arrangements are required. Roller bearings are stiffer than ball bearings because of the contact conditions between the rolling elements and raceways. Stiffness can be enhanced by preloading the bearing.

A comparison of the radial and axial stiffnesses of the different precision bearing types is shown in **Table 2**.

Axial displacement

Cylindrical roller bearings are particularly suitable as non-locating bearings. Axial displacements in both directions can be accommodated between the rollers and the raceway of one of the rings. Both inner and outer ring can therefore be mounted with an interference fit.

If non-separable bearings, e.g. angular contact ball bearings are used as non-locating bearings, one of the bearing rings must have a loose fit, generally the ring which does not rotate. However, this has a negative influence on the stiffness of the bearing arrangement system.

Speed

The speed at which a rolling bearing can operate is governed largely by the permissible operating temperature. Bearing types with low friction and thus low heat generation within the bearing are therefore the most suitable for high speed operation.

A comparison of the maximum speeds for precision bearings (single bearings and bearing combinations) is shown in **Table 2**.

Because of their design, thrust bearings do not permit such high speeds as radial bearings.

Heat generation

The heat generated in a bearing arrangement is of considerable importance for the operating conditions and performance of a machine. It is largely determined by the operating speed, but also depends on the bearing type, the method of lubrication, the degree of bearing preload and the load conditions.

As bearing type, operating speed and load are generally fixed for a given bearing arrangement, the method of lubrication and the quantity of lubricant are decisive with respect to heat generation.













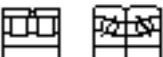

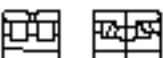

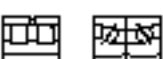

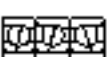

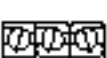

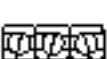

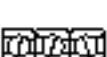

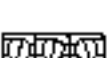

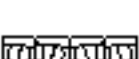
Spindle bearing arrangements

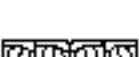
The most important factors which have to be considered when designing bearing arrangements for machine tool spindles as already mentioned are the stiffness, the running accuracy, the speed and the operating temperature.

In order to satisfy these partly conflicting demands, precision bearings of widely differing designs are used.

The most commonly used bearing combinations are shown in **Table 2** with their most important characteristics. The guideline values for stiffness given in the table relate to spindles having a diameter of 100 mm at the work side and 90 mm at the opposite side. As the length of the spindle and individual operating conditions are not considered, the table can only provide approximate values.

Table 2

Bearing combination Work side	Opposite side	Characteristics		Speed	Running accuracy	Load carrying capacity radial
		Stiffness axial	radial			
–		%				
		NN 30 K/SP	100	100	100	100
		NN 30 K/SP	66	100	118	100
		NN 30 K/SP	45	100	135	100
		N 10 K/SP	45	73	135	80
		70 CD/P4ADBA	81	63	160	100
		70 CD/P4ADBA	81	66	180	100
		NN 30 K/SP	81	58	155	110
		NN 30 K/SP	81	59	155	90
		719 CD/P4ADBA	81	57	160	75
		N 10 K/SP	42	71	180	70
		N 10 K/SP	57	85	155	100
		N 10 K/SP	21	42	180	55
		70 CD/P4ADBA	28	61	230	85
		70 CE/P4ADT	21	55	360	50

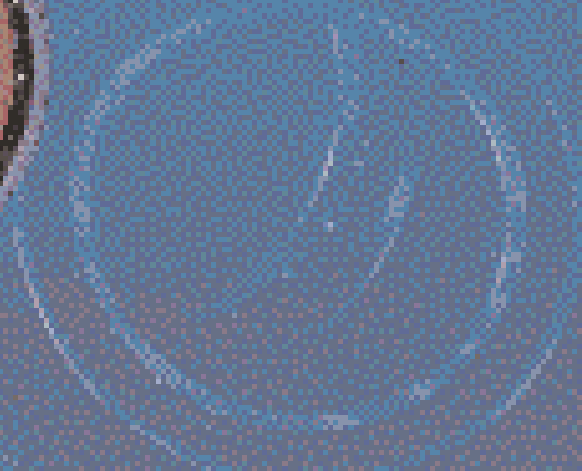
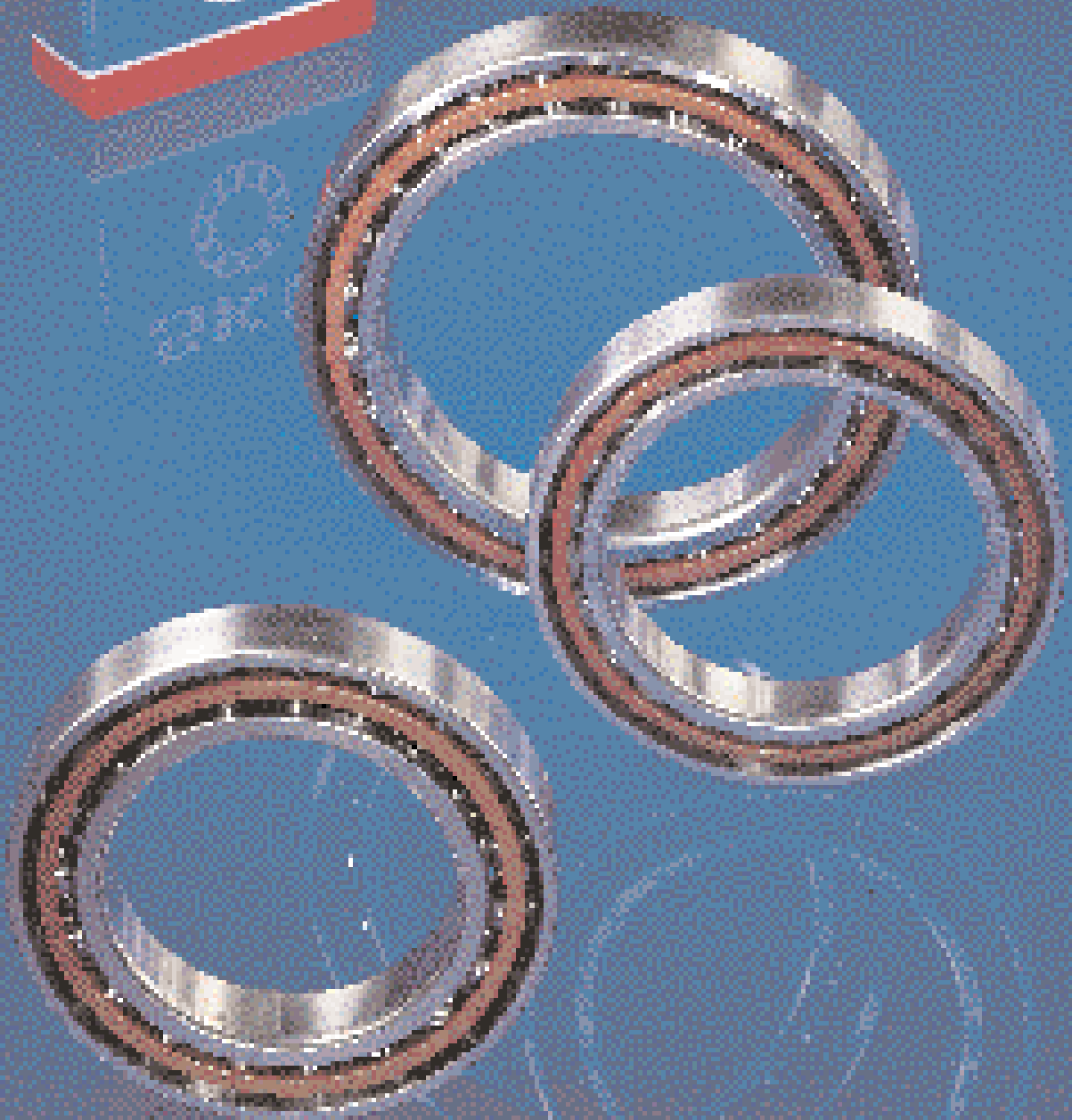

Angular contact ball bearings

SKF produces state-of-the-art precision angular contact ball bearings for the work spindles of machine tools and similar applications where demands on running accuracy and speed capability are high or very high.

SKF precision angular contact ball bearings (→ **fig 1**) are produced in three different dimension series 719, 70 and 72 and are available with contact angles of 15° (designation suffix CD) and 25° (designation suffix ACD) (→ **fig 2**).

To meet the various demands with regard to running accuracy, speed capability, stiffness as well as load carrying capacity placed on precision bearing arrangements in an optimum manner, three different types of single row angular contact ball bearings are available:

- precision angular contact ball bearings of standard design,
- hybrid precision angular contact ball bearings (with ceramic balls), and
- precision angular contact ball bearings with modified internal geometry.

Precision angular contact ball bearings, standard design

SKF precision angular contact ball bearings of the standard design are made of carbon chromium steel. They

are available in the three bearing series with a contact angle of 15° (designation suffix CD) as well as with a contact angle of 25° (designation suffix ACD), (→ **fig 2**). The bearings with the larger contact angle are used primarily where high axial stiffness or high axial load carrying capacity are required.

Fig 3 on page 10 shows the different cross sections of the three bearing series with reference to the outside and bore diameters. The different space requirements of the three series are clearly apparent. Each series has typ-

Fig 1

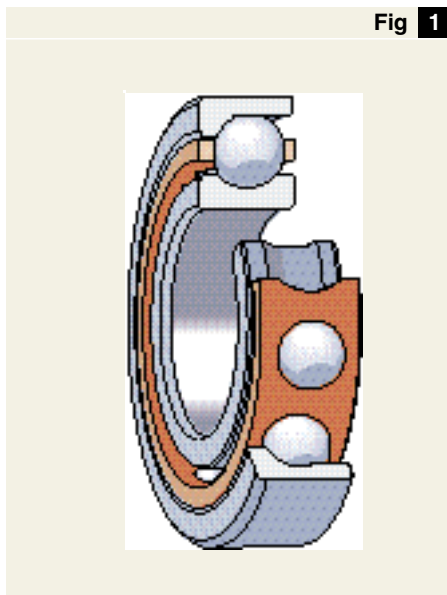

Precision angular contact ball bearing for machine tool work spindles

Precision angular contact ball bearings of standard design

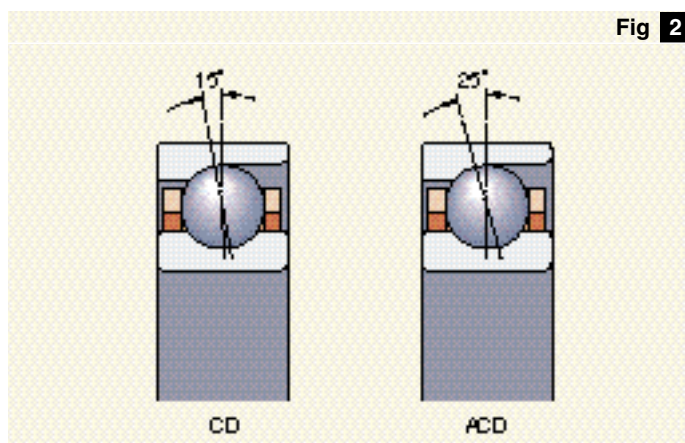
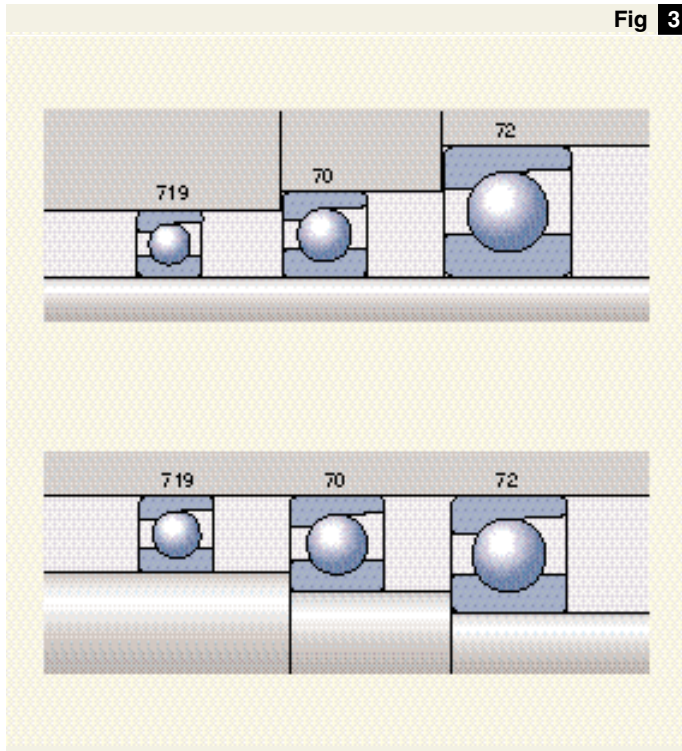

Fig 2



Comparison of the cross sections of bearings of series 719, 70 and 72

ical properties which are appropriate to different applications.

Hybrid precision angular contact ball bearings

SKF hybrid precision angular contact ball bearings have the same design as the standard bearings but have ceramic balls instead of steel balls (→ fig 4). The silicon nitride ceramic material demonstrates a good combination of stiffness, hardness, wear resistance and density. The ceramic balls have 60 % lower density than steel balls so that the centrifugal forces in the bearing are much reduced. The lighter balls also cause less alteration of the contact angle and increase the dynamic accuracy of the bearing.

A 70 % smaller thermal expansion than for steel balls considerably reduces the influence of temperature changes on the bearing preload. It is therefore possible for hybrid bearings to operate at speeds which are some 20 % higher than for all-steel bearings without any risk of uncontrolled preload increases occurring.

The modulus of elasticity of the ceramic material is some 50 % greater than for steel. Thus hybrid bearings are stiffer, by up to 20 % at elevated speeds. Power losses are reduced by approximately 10 % compared with all-steel bearings.

SKF hybrid precision angular contact ball bearings are identified by the designation suffix HC, e.g. 71912 CDGA/HCP4A.

Precision angular contact ball bearings with modified internal design

The majority of the high demands associated with machine tool spindle applications can be met with the standard design of precision angular contact ball bearings with steel balls or with ceramic balls. For applications where maximum speed capability and stiffness are required, however, some sizes of series 719 and 70 are also available with modified internal design. These bearings of the CE design have a contact angle of 15° and incorporate more, but smaller balls than the corresponding sizes of series 719 CD or 70 CD (→ fig 5) except for the smallest sizes. The gyratory forces exerted by the balls on the outer ring raceways are much reduced for the small balls compared with the larger balls of the standard design and the surface pressure in the rolling contact is also reduced.

By using smaller balls, it is possible for the bearing rings to be correspondingly thicker for the same envelope dimensions. This means that any inaccuracies of form of the bearing seatings on the shaft or in the housing will have less influence on the accuracy of form of the bearing rings so that the bearings will have enhanced running accuracy. The CE-design bearings are fully interchangeable with the standard CD-design bearings. The CE-design bearings are characterised by very high speed capability compared with the CD-design bearings .

The bearings are available in an all-steel version, the CE design, or in a hybrid version with ceramic balls identified by the designation suffix CE/HC. They are produced as standard to tolerance class P4A specifications.

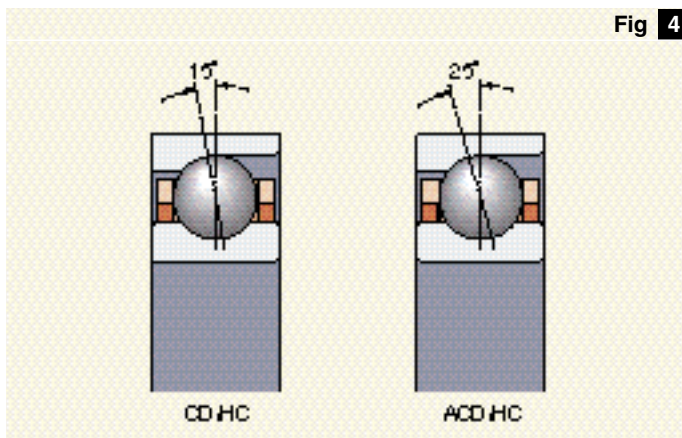

Standard designs of SKF hybrid angular contact ball bearings

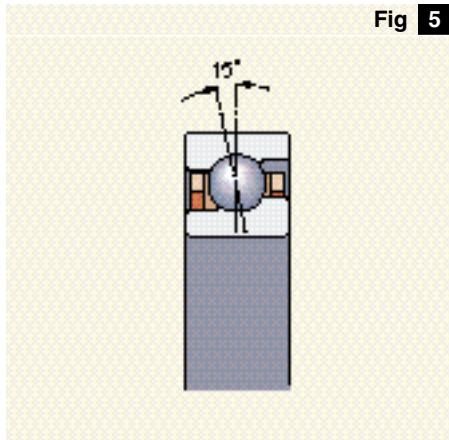

Precision angular contact ball bearing, CE design

Fig 5

Matched bearing sets

All SKF precision angular contact ball bearings can be supplied as required in complete sets of two, three or four matched bearings in the arrangements shown in **fig 6**.

The bearings of a set are matched in production so that when they are mounted immediately adjacent to each other in the prescribed order, a given preload will be obtained or the load will be evenly distributed. The bore and outside diameters of the bearings of a set differ from each other by half the permissible diameter tolerance. The difference is even smaller for bearings to tolerance class PA9A.

To facilitate correct mounting, the bearings of a set have a “V” marking on their outside cylindrical surface. The prescribed order must be adhered to if the set is to perform properly. The “V” marking also indicates how the set should be mounted in relation to the axial load. The point of the “V” indicates the direction in which the axial load, or where axial load acts in both directions, the greater of the axial loads, should act on the inner ring.

The bearings of a set are supplied in a unit package but are individually packed within the package.

Bearings for universal pairing

A special execution of the SKF precision angular contact ball bearings is that for universal pairing. These bearings are matched during production so that they can be mounted immediately adjacent to each other in random order (back-to-back, face-to-face or in tandem) and will then have a light, medium or heavy preload when arranged back-to-back or face-to-face, as required.

Bearings for universal pairing are identified by the designation suffix G followed by A, B or C for the preload class, e.g. 71906 CDGA/P4A. When ordering it should be remembered that the number of individual bearings should be stated and not the number of pairs.

Sets of two bearings for universal pairing with matched bore and outside diameters are also available. Depending on preload class, these carry the designation suffix DGA, DGB or DGC, e.g. 71906 CD/P4ADGA. In this case, however, the number of pairs required must be stated, not the number of individual bearings.

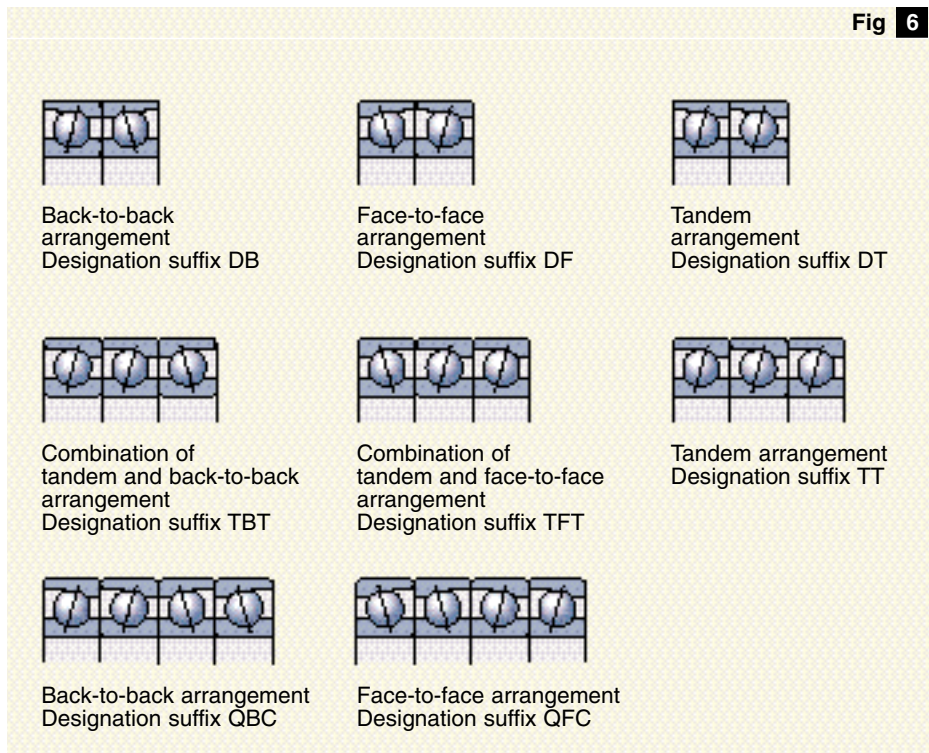

Fig 6

Possible combinations of matched bearing sets

Angular contact ball bearings

Bearings of series 719: preload in bearings for universal pairing and bearing sets arranged back-to-back or face-to-face.

Hybrid bearings of the CD/HC and ACD/HC designs are only available with axial preload to classes A and B.

Dimensions

The boundary dimensions of the bearings shown in the bearing tables conform to ISO 15-1981, Dimension Series 19, 10 and 02.

Tolerances

SKF precision angular contact ball bearings are produced as standard to tolerance class P4A specifications. They may also be supplied with greater accuracy to PA9A, to order.

The actual values of the tolerances for classes P4A and PA9A are given in

Tables 1 and 2, pages 67 and 68.

They correspond largely to ISO 492:1994 and ANSI/ABMA Std. 20-1987.

Preload

To meet different requirements regarding speed capability, stiffness etc. matched sets of two precision angular contact ball bearings arranged back-to-back or face-to-face are supplied in three preload classes by SKF.

Class A: light preload

Class B: medium preload

Class C: heavy preload

The magnitude of the preload depends on the series, the contact angle and the bearing size. The actual values are given in **Tables 1 to 3**. The values apply to unmounted pairs arranged back-to-back and face-to-face and are nominal values.

Bearing sets of three or four bearings in tandem/back-to-back or tandem/face-to-face arrangements have a higher preload than that given in **Tables 1 to 3**. The actual preload can be obtained by multiplying the table values by

1,35 for TBT and TFT sets
2,00 for QBC and QFC sets
1,60 for QBT and QFT sets

Table 1

Bearing Bore diameter	Size	Axial preload in bearing of series 719 of designs						CE, CE/HC Class	
		CD, CD/HC Class			ACD, ACD/HC Class			A	B
mm	–	A	B	C	A	B	C	A	B
		N							
10	00	10	20	40	15	30	60	–	–
12	01	10	20	40	15	30	60	–	–
15	02	15	30	60	25	50	100	–	–
17	03	15	30	60	25	50	100	–	–
20	04	25	50	100	35	70	140	–	–
25	05	25	50	100	40	80	160	–	–
30	06	25	50	100	40	80	160	–	–
35	07	35	70	140	60	120	240	–	–
40	08	45	90	180	70	140	280	–	–
45	09	50	100	200	80	160	320	–	–
50	10	50	100	200	80	160	320	–	–
55	11	70	140	280	120	240	480	–	–
60	12	70	140	280	120	240	480	100	200
65	13	80	160	320	120	240	480	–	–
70	14	130	260	520	200	400	800	150	300
75	15	130	260	520	210	420	840	–	–
80	16	140	280	560	220	440	880	160	320
85	17	170	340	680	270	540	1 080	–	–
90	18	180	360	720	280	560	1 120	220	440
95	19	190	380	760	290	580	1 160	–	–
100	20	230	460	920	360	720	1 440	–	–
105	21	230	460	920	360	720	1 440	–	–
110	22	230	460	920	370	740	1 480	–	–
120	24	290	580	1 160	450	900	1 800	–	–
130	26	350	700	1 400	540	1 080	2 160	–	–
140	28	360	720	1 440	560	1 120	2 240	–	–
150	30	470	940	1 880	740	1 480	2 960	–	–
160	32	490	980	1 960	800	1 600	3 200	–	–
170	34	500	1 000	2 000	800	1 600	3 200	–	–
180	36	630	1 260	2 520	1 000	2 000	4 000	–	–
190	38	640	1 280	2 560	1 000	2 000	4 000	–	–
200	40	800	1 600	3 200	1 250	2 500	5 000	–	–
220	44	850	1 700	3 400	1 300	2 600	5 200	–	–
240	48	850	1 700	3 400	1 350	2 700	5 400	–	–

Table 2

Bearings of series 70: preload in bearings for universal pairing and bearing sets arranged back-to-back or face-to-face.

Hybrid bearings of the CD/HC and ACD/HC designs are only available with axial preload to classes A and B.

Bearing Bore diameter	Size	Axial preload in bearings of series 70 of designs						CE, CE/HC Class	
		CD, CD/HC Class			ACD, ACD/HC Class			A	B
mm	–	A	B	C	A	B	C	A	B
		N							
8	8	10	20	40	20	40	80	–	–
9	9	10	20	40	20	40	80	–	–
10	00	15	30	60	25	50	100	–	–
12	01	15	30	60	25	50	100	–	–
15	02	20	40	80	30	60	120	–	–
17	03	25	50	100	40	80	160	–	–
20	04	35	70	140	50	100	200	–	–
25	05	35	70	140	60	120	240	70	140
30	06	50	100	200	90	180	360	100	200
35	07	60	120	240	90	180	360	110	220
40	08	60	120	240	100	200	400	110	220
45	09	110	220	440	170	340	680	–	–
50	10	110	220	440	180	360	720	160	320
55	11	150	300	600	230	460	920	–	–
60	12	150	300	600	240	480	960	140	280
65	13	160	320	640	240	480	960	150	300
70	14	200	400	800	300	600	1 200	200	400
75	15	200	400	800	310	620	1 240	–	–
80	16	240	480	960	390	780	1 560	260	520
85	17	250	500	1 000	400	800	1 600	–	–
90	18	300	600	1 200	460	920	1 840	330	660
95	19	310	620	1 240	480	960	1 920	–	–
100	20	310	620	1 240	500	1 000	2 000	350	700
105	21	360	720	1 440	560	1 180	2 360	–	–
110	22	420	840	1 680	650	1 300	2 600	–	–
120	24	430	860	1 720	690	1 380	2 760	–	–
130	26	560	1 120	2 240	900	1 800	3 600	–	–
140	28	570	1 140	2 280	900	1 800	3 600	–	–
150	30	650	1 300	2 600	1 000	2 000	4 000	–	–
160	32	730	1 460	2 920	1 150	2 300	4 600	–	–
170	34	800	1 600	3 200	1 250	2 500	5 000	–	–
180	36	900	1 800	3 600	1 450	2 900	5 800	–	–
190	38	950	1 900	3 800	1 450	2 900	5 800	–	–
200	40	1 100	2 200	4 400	1 750	3 500	7 000	–	–
220	44	1 250	2 500	5 000	2 000	4 000	8 000	–	–
240	48	1 300	2 600	5 200	2 050	4 1000	8 200	–	–

Cages

All SKF precision angular contact ball bearings are fitted with an outer ring centred cage (→ fig 7) which is particularly lightweight so that gyratory forces are kept to a minimum. The cage form allows uninterrupted access of lubricant to the ball/raceway contacts.

The present fabric reinforced phenolic resin cages are gradually being replaced by an even more stable cage of PEEK (polyether ether ketone). Bearings with the new PEEK cage are identified by the designation suffix TNH, e.g. 71916 CDTNH/P4A.

Speed ratings

The speed ratings quoted in the bearing tables are guideline values and apply provided the bearings operate under light loads ($P \leq 0,06 C$) and are lightly preloaded by means of springs. Heat transport away from the bearing position should also be good.

The values given under oil spot lubrication are maximum values, as are those under grease lubrication; they can be attained using a good quality grease of soft consistency.

The speed ratings for bearing sets can be obtained by multiplying the ratings quoted for single bearings by the reduction factors given in Table 4.

Fig 7



Cage made of fabric reinforced phenolic resin

Angular contact ball bearings

Bearings of series 72: preload in bearings for universal pairing and bearing sets arranged back-to-back or face-to-face.

Hybrid bearings of the CD/HC and ACD/HC designs are only available with axial preload to classes A and B.

Table 3

Bearing Bore diameter	Size	Axial preload in bearings of series 72 of designs					
		CD, CD/HC Class			ACD, ACD/HC Class		
		A	B	C	A	B	C
mm	–	N					
10	00	20	40	80	35	70	140
12	01	20	40	80	35	70	140
15	02	30	60	120	45	90	180
17	03	35	70	140	60	120	240
20	04	45	90	180	70	140	280
25	05	50	100	200	80	160	320
30	06	90	180	360	150	300	600
35	07	120	240	480	190	380	760
40	08	150	300	600	240	480	960
45	09	160	320	640	260	520	1 040
50	10	170	340	680	260	520	1 040
55	11	210	420	840	330	660	1 320
60	12	250	500	1 000	400	800	1 600
65	13	290	580	1 160	450	900	1 800
70	14	300	600	1 200	480	960	1 920
75	15	310	620	1 240	500	1 000	2 000
80	16	370	740	1 480	580	1 160	2 320
85	17	370	740	1 480	600	1 200	2 400
90	18	480	960	1 920	750	1 500	3 000
95	19	520	1 040	2 080	850	1 700	3 400
100	20	590	1 180	2 360	950	1 900	3 800
105	21	650	1 300	2 600	1 000	2 000	4 000
110	22	670	1 340	2 680	1 050	2 100	4 200
120	24	750	1 500	3 000	1 200	2 400	4 800

Reduction factors for speed ratings

Table 4

Bearing arrangement	Reduction factors for preload arrangements					
	Bearings of designs CD, CD/HC, ACD, ACD/HC, CE and CE/HC with $d \leq 50$ mm and preload to class			CE and CE/HC with $d > 50$ mm and preload to class		
	A	B	C	A	B	
Set of two bearings arranged in tandem	0,90	0,80	0,65	0,90	0,70	
Set of two bearings arranged back-to-back or face-to-face	0,80	0,70	0,55	0,75	0,60	
Set of three bearings	0,70	0,55	0,35	0,65	0,40	
Set of four bearings	0,65	0,45	0,25	0,55	0,30	

Load carrying capacity of bearing sets

The values given in the bearing tables for the basic dynamic and static load ratings apply to single bearings. The basic dynamic load ratings for sets of bearings in any order can be obtained by multiplying the C value for a single bearing by

- 1,62 for sets of two bearings
- 2,16 for sets of three bearings
- 2,64 for sets of four bearings.

The corresponding basic static load ratings are obtained by multiplying the C₀ value for a single bearing by the number of bearings in the set (2, 3 or 4).

Equivalent dynamic bearing load

For single row angular contact ball bearings arranged singly or paired in tandem

$$P = F_r \quad \text{when } F_a/F_r \leq e$$

$$P = XF_r + YF_a \quad \text{when } F_a/F_r > e$$

The appropriate values for X and Y for the different contact angles will be found in **Table 5**. When calculating bearing pairs, F_r and F_a represent the forces acting on the bearing pair.

For bearing pairs arranged back-to-back or face-to-face

$$P = F_r + Y_1F_a \quad \text{when } F_a/F_r \leq e$$

$$P = XF_r + Y_2F_a \quad \text{when } F_a/F_r > e$$

The appropriate values for X, Y₁ and Y₂ for the different contact angles will be found in **Table 6**. When calculating bearing pairs, F_r and F_a represent the forces acting on the bearing pair.

When calculating sets of more than two bearings arranged back-to-back or face-to-face, it is necessary to consider the number of bearings supporting the load in each direction.

Equivalent static bearing load

For single row angular contact ball bearings arranged singly or paired in tandem

$$P_0 = 0,5 F_r + Y_0F_a$$

If P₀ < F_r, P₀ = F_r should be used.

The appropriate values for Y₀ for the different contact angles will be found in **Table 5**. When calculating bearing pairs, F_r and F_a represent the forces acting on the bearing pair.

For bearing pairs arranged back-to-back or face-to-face

$$P_0 = F_r + Y_0F_a$$

The appropriate values for Y₀ for the different contact angles will be found in **Table 6**. When calculating bearing pairs, F_r and F_a represent the forces acting on the bearing pair.

When calculating sets of more than two bearings arranged back-to-back or face-to-face, it is necessary to consider the number of bearings supporting the load in each direction.

Calculation factors for single row angular contact ball bearings arranged singly or paired in tandem

Table 5				
f ₀ F _a /C ₀	e	X	Y	Y ₀
Contact angle 15° (designation suffix CD and CE)				
≤ 0,178	0,38	0,44	1,47	0,46
0,357	0,40	0,44	1,40	0,46
0,714	0,43	0,44	1,30	0,46
1,07	0,46	0,44	1,23	0,46
1,43	0,47	0,44	1,19	0,46
2,14	0,50	0,44	1,12	0,46
3,57	0,55	0,44	1,02	0,46
≥ 5,35	0,56	0,44	1,00	0,46
Contact angle 25° (designation suffix ACD)				
–	0,68	0,41	0,87	0,38

Calculation factors for single row angular contact ball bearing pairs arranged back-to-back or face-to-face

Table 6					
2 f ₀ F _a /C ₀	e	X	Y ₁	Y ₂	Y ₀
Contact angle 15° (designation suffix CD and CE)					
≤ 0,178	0,38	0,72	1,65	2,39	0,92
0,357	0,40	0,72	1,57	2,28	0,92
0,714	0,43	0,72	1,46	2,11	0,92
1,07	0,46	0,72	1,38	2,00	0,92
1,43	0,47	0,72	1,34	1,93	0,92
2,14	0,50	0,72	1,26	1,82	0,92
3,57	0,55	0,72	1,14	1,66	0,92
≥ 5,35	0,56	0,72	1,12	1,63	0,92
Contact angle 25° (designation suffix ACD)					
–	0,68	0,67	0,92	1,41	0,76

Precision angular contact ball bearings
d 8 – 20 mm

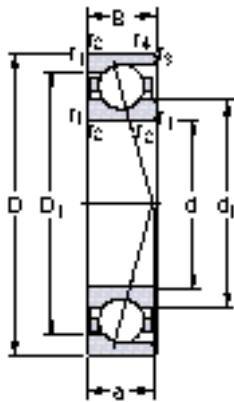

CD, ACD

Principal dimensions			Basic load ratings		Fatigue load limit P_u	Calculation factor f_0	Speed ratings		Mass	Designation
d	D	B	C	C_0			Lubrication grease	oil spot		
mm			N		N	–	r/min		kg	–
8	22	7	2 960	1 160	49	8,4	70 000	110 000	0,011	708 CD
	22	7	2 910	1 120	48	–	67 000	100 000	0,011	708 ACD
9	24	7	3 250	1 340	57	8,8	70 000	110 000	0,014	709 CD
	24	7	3 120	1 290	54	–	63 000	95 000	0,014	709 ACD
10	22	6	2 510	1 100	48	9,5	70 000	110 000	0,009	71900 CD
	22	6	2 420	1 060	45	–	63 000	95 000	0,009	71900 ACD
	26	8	4 100	1 660	71	8,3	67 000	100 000	0,018	7000 CD
	26	8	3 970	1 600	67	–	56 000	85 000	0,018	7000 ACD
	30	9	5 400	2 200	93	8,2	60 000	90 000	0,029	7200 CD
	30	9	5 200	2 120	90	–	53 000	80 000	0,029	7200 ACD
12	24	6	2 650	1 250	53	9,8	63 000	95 000	0,010	71901 CD
	24	6	2 550	1 180	50	–	56 000	85 000	0,010	71901 ACD
	28	8	4 490	1 900	80	8,7	60 000	90 000	0,020	7001 CD
	28	8	4 360	1 830	78	–	53 000	80 000	0,020	7001 ACD
	32	10	5 850	2 550	108	8,5	53 000	80 000	0,036	7201 CD
	32	10	5 720	2 450	104	–	48 000	70 000	0,036	7201 ACD
15	28	7	3 970	1 900	80	9,6	56 000	85 000	0,015	71902 CD
	28	7	3 770	1 800	78	–	50 000	75 000	0,015	71902 ACD
	32	9	5 200	2 450	104	9,3	50 000	75 000	0,028	7002 CD
	32	9	4 940	2 320	98	–	45 000	67 000	0,028	7002 ACD
	35	11	7 410	3 350	140	8,5	48 000	70 000	0,043	7202 CD
	35	11	7 150	3 200	134	–	43 000	63 000	0,043	7202 ACD
17	30	7	4 160	2 080	88	9,8	50 000	75 000	0,017	71903 CD
	30	7	3 970	2 000	85	–	45 000	67 000	0,017	71903 ACD
	35	10	6 760	3 250	137	9,1	48 000	70 000	0,037	7003 CD
	35	10	6 500	3 100	132	–	40 000	60 000	0,037	7003 ACD
	40	12	9 230	4 150	176	8,5	43 000	63 000	0,062	7203 CD
	40	12	8 840	4 000	170	–	38 000	56 000	0,062	7203 ACD
20	37	9	6 050	3 200	137	9,8	43 000	63 000	0,035	71904 CD
	37	9	5 720	3 050	129	–	38 000	56 000	0,035	71904 ACD
	42	12	8 710	4 300	180	9,2	38 000	56 000	0,065	7004 CD
	42	12	8 320	4 150	173	–	34 000	50 000	0,065	7004 ACD
	47	14	11 900	5 850	245	8,7	36 000	53 000	0,10	7204 CD
	47	14	11 400	5 600	236	–	32 000	48 000	0,10	7204 ACD

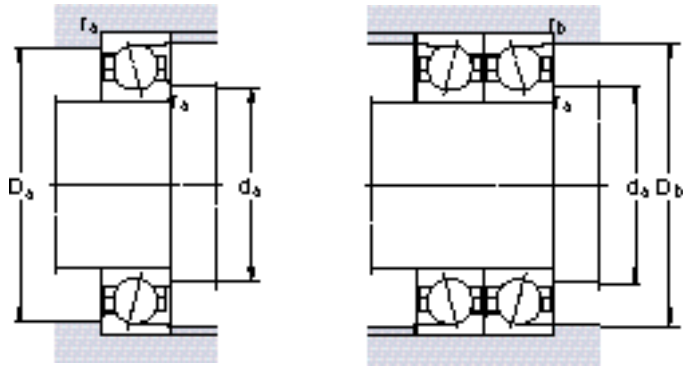

Dimensions

Abutment and fillet dimensions

d	d ₁ ≈	D ₁ ≈	r _{1,2} min	r _{3,4} min	a	d _a min	D _a max	D _b max	r _a max	r _b max
mm	mm									
8	12,6	17,7	0,3	0,1	6	10	20	20,4	0,3	0,1
	12,6	17,5	0,3	0,1	7	10	20	20,4	0,3	0,1
9	13,9	19,5	0,3	0,1	6	11	22	22,4	0,3	0,1
	13,9	19,2	0,3	0,1	7	11	22	22,4	0,3	0,1
10	13,9	18,1	0,3	0,1	5	12	20	20,8	0,3	0,1
	13,9	18,1	0,3	0,1	7	12	20	20,8	0,3	0,1
	15,1	21,3	0,3	0,1	6	12	24	24,4	0,3	0,1
	15,1	21	0,3	0,1	8	12	24	24,4	0,3	0,1
12	16,8	23,3	0,6	0,3	7	15	25	28	0,6	0,3
	16,8	23,3	0,6	0,3	9	15	25	28	0,6	0,3
	15,9	20,1	0,3	0,1	5	14	22	22,8	0,3	0,1
	15,9	20,1	0,3	0,1	7	14	22	22,8	0,3	0,1
15	17,1	23,3	0,3	0,1	7	14	26	26,4	0,3	0,1
	17,1	23	0,3	0,1	9	14	26	26,4	0,3	0,1
	18,2	25,8	0,6	0,3	8	17	27	30	0,6	0,3
	18,2	25,8	0,6	0,3	10	17	27	30	0,6	0,3
17	19,1	23,9	0,3	0,1	6	17	26	26,8	0,3	0,1
	19,1	23,9	0,3	0,1	9	17	26	26,8	0,3	0,1
	20,6	26,8	0,3	0,1	8	17	30	30,4	0,3	0,1
	20,6	26,5	0,3	0,1	10	17	30	30,4	0,3	0,1
20	21,5	29,1	0,6	0,3	9	20	30	33	0,6	0,3
	21,5	29,1	0,6	0,3	12	20	30	33	0,6	0,3
	21,1	25,9	0,3	0,1	7	19	28	28,8	0,3	0,1
	21,1	25,9	0,3	0,1	9	19	28	28,8	0,3	0,1
25	22,9	29,6	0,3	0,1	9	19	33	33,4	0,3	0,1
	22,9	29,2	0,3	0,1	11	19	33	33,4	0,3	0,1
	24,2	32,8	0,6	0,3	10	22	35	38	0,6	0,3
	24,2	32,8	0,6	0,3	13	22	35	38	0,6	0,3
30	25,4	31,6	0,3	0,15	8	22	35	35,8	0,3	0,1
	25,4	31,6	0,3	0,15	11	22	35	35,8	0,3	0,1
	26,9	35,1	0,6	0,3	10	25	37	40	0,6	0,3
	26,9	35,1	0,6	0,3	13	25	37	40	0,6	0,3
35	29,1	38,7	1	0,3	12	26	41	45	1	0,3
	29,1	38,7	1	0,3	15	26	41	45	1	0,3

Precision angular contact ball bearings

d 25 – 45 mm

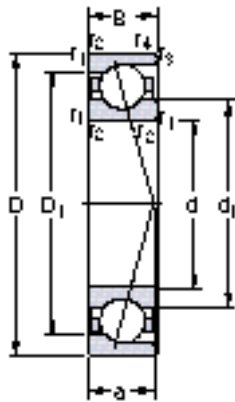

CD, ACD

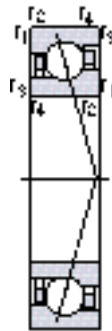

CE

1

Principal dimensions			Basic load ratings		Fatigue load limit P_u	Calculation factor f_0	Speed ratings		Mass	Designation
d	D	B	C	C_0			Lubrication grease	oil spot		
mm			N		N	–	r/min	kg	–	
25	42	9	6 760	4 000	170	10	36 000	53 000	0,042	71905 CD
	42	9	6 370	3 800	160	–	32 000	48 000	0,042	71905 ACD
25	47	12	9 560	5 200	220	9,6	34 000	50 000	0,075	7005 CD
	47	12	8 710	4 550	193	8,4	43 000	65 000	0,078	7005 CE
	47	12	9 230	5 000	212	–	28 000	43 000	0,075	7005 ACD
25	52	15	13 500	7 200	305	9,1	30 000	45 000	0,14	7205 CD
	52	15	13 000	6 950	290	–	26 000	40 000	0,14	7205 ACD
30	47	9	7 150	4 550	193	10	30 000	45 000	0,048	71906 CD
	47	9	6 760	4 300	183	–	26 000	40 000	0,048	71906 ACD
30	55	13	14 300	8 000	345	9,4	28 000	43 000	0,11	7006 CD
	55	13	13 000	6 950	300	8,2	36 000	53 000	0,11	7006 CE
	55	13	13 800	7 650	325	–	24 000	38 000	0,11	7006 ACD
30	62	16	24 200	16 000	670	14	24 000	38 000	0,19	7206 CD
	62	16	23 400	15 300	640	–	20 000	34 000	0,19	7206 ACD
35	55	10	9 750	6 550	275	10	26 000	40 000	0,074	71907 CD
	55	10	9 230	6 200	260	–	22 000	36 000	0,074	71907 ACD
35	62	14	15 600	9 500	400	9,7	22 000	36 000	0,15	7007 CD
	62	14	14 000	8 300	355	8,5	30 000	45 000	0,15	7007 CE
	62	14	14 800	9 000	380	–	19 000	32 000	0,15	7007 ACD
35	72	17	31 900	21 600	915	14	20 000	34 000	0,28	7207 CD
	72	17	30 700	20 800	880	–	18 000	30 000	0,28	7207 ACD
40	62	12	12 400	8 500	360	10	20 000	34 000	0,11	71908 CD
	62	12	11 700	8 000	340	–	18 000	30 000	0,11	71908 ACD
40	68	15	16 800	11 000	465	10	19 000	32 000	0,19	7008 CD
	68	15	15 100	9 500	405	8,7	26 000	40 000	0,19	7008 CE
	68	15	15 900	10 400	440	–	18 000	30 000	0,19	7008 ACD
40	80	18	41 000	28 000	1 180	14	18 000	30 000	0,36	7208 CD
	80	18	39 000	27 000	1 140	–	16 000	26 000	0,36	7208 ACD
45	68	12	13 000	9 500	400	11	19 000	32 000	0,13	71909 CD
	68	12	12 400	9 000	380	–	17 000	28 000	0,13	71909 ACD
45	75	16	28 600	22 400	950	15	18 000	30 000	0,23	7009 CD
	75	16	27 600	21 600	900	–	16 000	26 000	0,23	7009 ACD
45	85	19	42 300	31 000	1 320	14	17 000	28 000	0,41	7209 CD
	85	19	41 000	30 000	1 250	–	15 000	24 000	0,41	7209 ACD

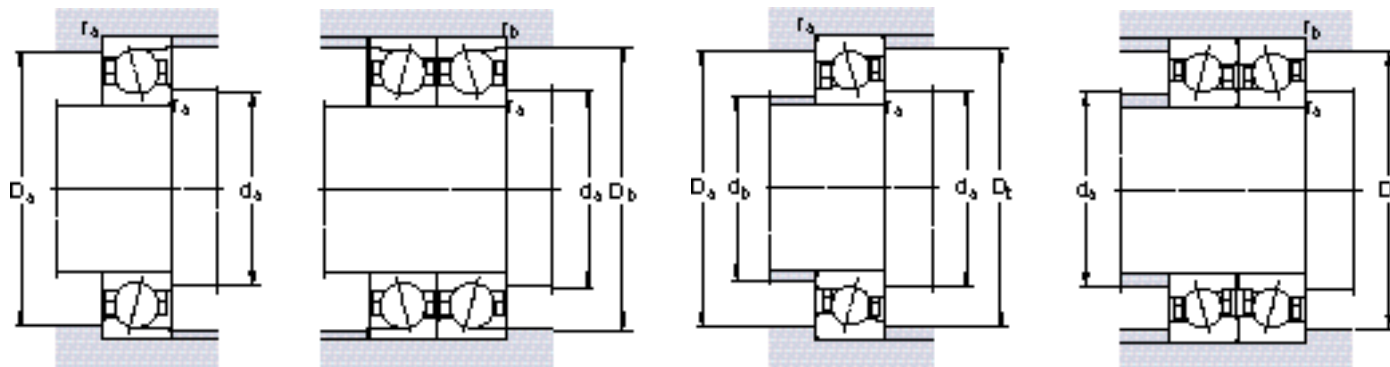

Dimensions

Abutment and fillet dimensions

d	d ₁ ≈	D ₁ ≈	r _{1,2} min	r _{3,4} min	a	d _a min	d _b min	D _a max	D _b max	r _a max	r _b max
mm	mm										
25	30,4	36,6	0,3	0,15	9	27	–	40	40,8	0,3	0,1
	30,4	36,6	0,3	0,15	12	27	–	40	40,8	0,3	0,1
	31,9	40,1	0,6	0,3	11	30	–	42	45	0,6	0,3
	32,2	39,9	0,6	0,3	11	30	27	42	45	0,6	0,3
	31,9	40,1	0,6	0,3	15	30	–	42	45	0,6	0,3
30	34,1	43,7	1	0,3	13	31	–	46	50	1	0,3
	34,1	43,7	1	0,3	17	31	–	46	50	1	0,3
	35,4	41,6	0,3	0,15	10	32	–	45	45,8	0,3	0,1
	35,4	41,6	0,3	0,15	14	32	–	45	45,8	0,3	0,1
	38,1	46,9	1	0,3	12	36	–	49	53	1	0,3
35	37,7	47,3	1	0,3	12	36	32	49	53	1	0,3
	38,1	46,9	1	0,3	17	36	–	49	53	1	0,3
	40,3	51,7	1	0,3	14	36	–	56	60	1	0,3
	40,3	51,7	1	0,3	19	36	–	56	60	1	0,3
	41,2	48,8	0,6	0,15	11	40	–	50	53,8	0,6	0,1
40	41,2	48,8	0,6	0,15	16	40	–	50	53,8	0,6	0,1
	43,7	53,3	1	0,3	14	41	–	56	60	1	0,3
	43,7	53,3	1	0,3	14	41	37	56	60	1	0,3
	43,7	53,3	1	0,3	19	41	–	56	60	1	0,3
	47	60	1,1	0,3	16	42	–	65	70	1	0,3
45	47	60	1,1	0,3	21	42	–	65	70	1	0,3
	46,7	55,3	0,6	0,15	13	45	–	57	60,8	0,6	0,1
	46,7	55,3	0,6	0,15	18	45	–	57	60,8	0,6	0,1
	49,2	58,8	1	0,3	15	46	–	62	66	1	0,3
	49,2	58,8	1	0,3	15	46	42	62	66	1	0,3
50	49,2	58,8	1	0,3	20	46	–	62	66	1	0,3
	53	67	1,1	0,6	17	47	–	73	75	1	0,6
	53	67	1,1	0,6	23	47	–	73	75	1	0,6
	52,2	60,8	0,6	0,15	14	50	–	63	66,8	0,6	0,1
	52,2	60,8	0,6	0,15	19	50	–	63	66,8	0,6	0,1
55	54,7	65,3	1	0,3	16	51	–	69	73	1	0,3
	54,7	65,3	1	0,3	22	51	–	69	73	1	0,3
	57,5	72,5	1,1	0,6	18	52	–	78	80	1	0,6
	57,5	72,5	1,1	0,6	25	52	–	78	80	1	0,6

Precision angular contact ball bearings
d 50 – 70 mm

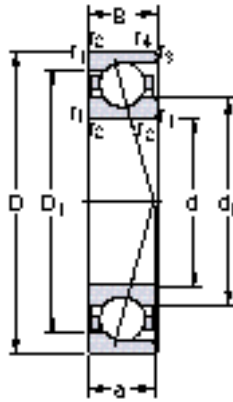

CD, ACD

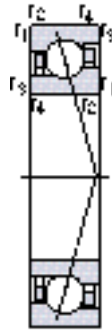

CE

Principal dimensions			Basic load ratings		Fatigue load limit P_u	Calculation factor f_0	Speed ratings		Mass	Designation
d	D	B	C	C_0			Lubrication grease	oil spot		
mm			N		N	–	r/min		kg	–
50	72	12	13 500	10 400	440	11	17 000	28 000	0,13	71910 CD
	72	12	12 700	9 800	415	–	16 000	26 000	0,13	71910 ACD
	80	16	29 600	24 000	1 020	15	17 000	28 000	0,25	7010 CD
	80	16	22 500	16 000	680	10	20 000	34 000	0,25	7010 CE
	80	16	28 100	23 200	980	–	15 000	24 000	0,25	7010 ACD
55	90	20	44 900	34 000	1 430	15	16 000	26 000	0,46	7210 CD
	90	20	42 300	32 500	1 390	–	14 000	22 000	0,46	7210 ACD
	80	13	19 500	14 600	620	10	16 000	26 000	0,18	71911 CD
	80	13	18 200	13 700	585	–	15 000	24 000	0,18	71911 ACD
60	90	18	39 700	32 500	1 370	15	15 000	24 000	0,37	7011 CD
	90	18	37 100	31 000	1 320	–	14 000	22 000	0,37	7011 ACD
	100	21	55 300	43 000	1 800	14	14 000	22 000	0,61	7211 CD
	100	21	52 700	40 500	1 730	–	13 000	20 000	0,61	7211 ACD
65	85	13	19 900	15 300	655	11	15 000	24 000	0,19	71912 CD
	85	13	13 500	12 200	520	11	18 000	30 000	0,19	71912 CE
	85	13	18 600	14 600	620	–	14 000	22 000	0,19	71912 ACD
70	95	18	40 300	34 500	1 500	15	14 000	22 000	0,40	7012 CD
	95	18	19 000	16 300	680	11	17 000	28 000	0,40	7012 CE
	95	18	39 000	33 500	1 400	–	13 000	20 000	0,40	7012 ACD
75	110	22	67 600	53 000	2 240	14	13 000	20 000	0,80	7212 CD
	110	22	63 700	50 000	2 120	–	11 000	18 000	0,80	7212 ACD
	90	13	20 800	17 000	710	11	14 000	22 000	0,21	71913 CD
	90	13	19 500	16 000	680	–	13 000	20 000	0,21	71913 ACD
80	100	18	41 600	37 500	1 600	16	14 000	22 000	0,42	7013 CD
	100	18	19 900	17 600	750	11	16 000	26 000	0,42	7013 CE
	100	18	39 000	35 500	1 500	–	12 000	19 000	0,42	7013 ACD
85	120	23	76 100	60 000	2 500	14	12 000	19 000	1,00	7213 CD
	120	23	72 800	57 000	2 400	–	10 000	17 000	1,00	7213 ACD
	100	16	34 500	34 000	1 430	16	13 000	20 000	0,33	71914 CD
90	100	16	20 300	18 300	780	11	16 000	26 000	0,32	71914 CE
	100	16	32 500	32 500	1 370	–	11 000	18 000	0,33	71914 ACD
	110	20	52 000	45 000	1 930	15	12 000	19 000	0,59	7014 CD
	110	20	27 000	23 600	1 000	11	15 000	24 000	0,58	7014 CE
	110	20	48 800	44 000	1 860	–	10 000	17 000	0,59	7014 ACD
95	125	24	79 300	64 000	2 750	15	11 000	18 000	1,10	7214 CD
	125	24	76 100	62 000	2 600	–	9 500	16 000	1,10	7214 ACD

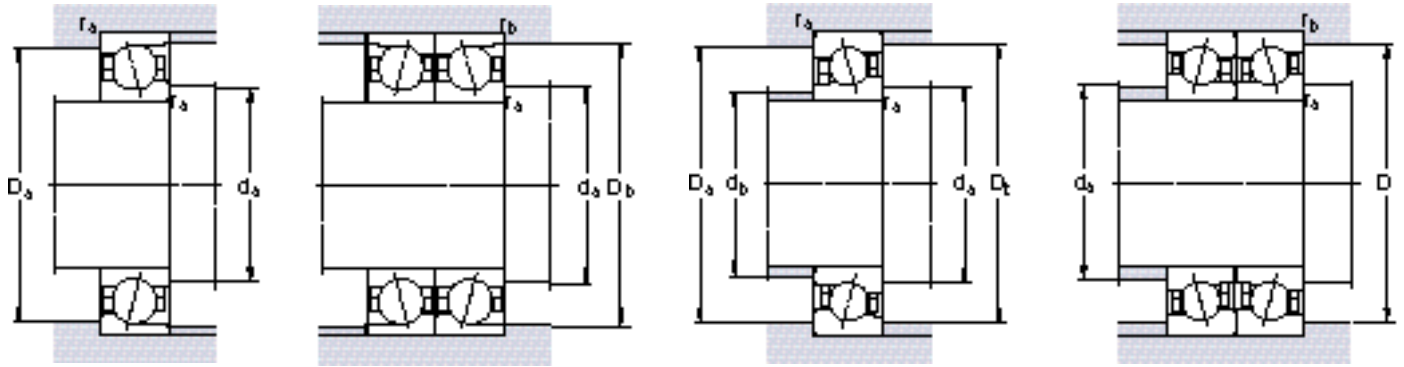

Dimensions

Abutment and fillet dimensions

d	d ₁ ≈	D ₁ ≈	r _{1,2} min	r _{3,4} min	a	d _a min	d _b min	D _a max	D _b max	r _a max	r _b max
mm	mm										
50	56,7	65,3	0,6	0,15	14	55	–	67	70,8	0,6	0,1
	56,7	65,3	0,6	0,15	20	55	–	67	70,8	0,6	0,1
	59,7	70,3	1	0,3	17	56	–	74	78	1	0,3
	59,3	70,8	1	0,3	17	56	54	74	78	1	0,3
55	59,7	70,3	1	0,3	17	56	–	74	78	1	0,3
	62,5	77,5	1,1	0,6	20	57	–	83	85	1	0,6
	62,5	77,5	1,1	0,6	27	57	–	83	85	1	0,6
	62,7	72,3	1	0,3	16	61	–	74	78	1	0,3
60	62,7	72,3	1	0,3	22	61	–	74	78	1	0,3
	66,3	78,7	1,1	0,6	19	62	–	83	86	1	0,6
	66,3	78,7	1,1	0,6	26	62	–	83	86	1	0,6
	69	85,9	1,5	0,6	21	64	–	91	95	1,5	0,6
65	69	85,9	1,5	0,6	29	64	–	91	95	1,5	0,6
	67,7	77,3	1	0,3	16	66	–	79	82	1	0,3
	68,6	76,4	1	0,3	16	66	63	79	82	1	0,3
	67,7	77,3	1	0,3	23	66	–	79	82	1	0,3
70	71,3	83,7	1,1	0,6	20	67	–	88	91	1	0,6
	72,7	82,3	1,1	0,6	19	67	64	88	91	1	0,6
	71,3	83,7	1,1	0,6	27	67	–	88	91	1	0,6
	75,6	94,4	1,5	0,6	23	69	–	101	105	1,5	0,6
75	75,6	94,4	1,5	0,6	31	69	–	101	105	1,5	0,6
	72,7	82,3	1	0,3	17	71	–	84	87	1	0,3
	72,7	82,3	1	0,3	25	71	–	84	87	1	0,3
	76,3	88,7	1,1	0,6	20	72	–	93	96	1	0,6
80	77,7	87,3	1,1	0,6	20	72	69	93	96	1	0,6
	76,3	88,7	1,1	0,6	28	72	–	93	96	1	0,6
	82,5	103	1,5	0,6	24	74	–	111	115	1,5	0,6
	82,5	103	1,5	0,6	33	74	–	111	115	1,5	0,6
85	79,3	90,7	1	0,3	19	76	–	94	97	1	0,3
	80,2	89,3	1	0,3	19	76	73	94	97	1	0,3
	79,3	90,7	1	0,3	28	76	–	94	97	1	0,3
	82,9	97,1	1,1	0,6	22	77	–	103	106	1	0,6
90	84,2	95,8	1,1	0,6	22	77	74	103	106	1	0,6
	82,9	97,1	1,1	0,6	31	77	–	103	106	1	0,6
	87	108	1,5	0,6	25	79	–	116	120	1,5	0,6
	87	108	1,5	0,6	35	79	–	116	120	1,5	0,6

Precision angular contact ball bearings
d 75 – 95 mm

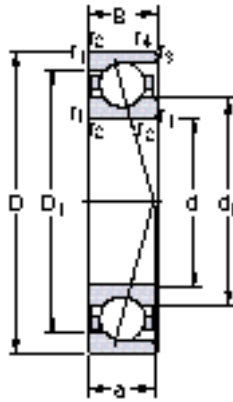

CD, ACD

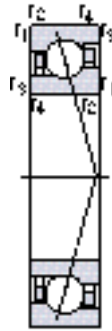

CE

Principal dimensions			Basic load ratings		Fatigue load limit P_u	Calculation factor f_0	Speed ratings		Mass	Designation
d	D	B	C	C_0			Lubrication grease	oil spot		
mm			N		N	–	r/min	kg	–	
75	105	16	35 800	37 500	1 560	16	12 000	19 000	0,35	71915 CD
	105	16	33 800	35 500	1 500	–	10 000	17 000	0,35	71915 ACD
	115	20	52 700	49 000	2 080	16	11 000	18 000	0,62	7015 CD
	115	20	49 400	46 500	1 960	–	9 500	16 000	0,62	7015 ACD
130	25	83 200	69 500	2 900	15	10 000	17 000	1,20	7215 CD	
	25	79 300	67 000	2 800	–	9 000	15 000	1,20	7215 ACD	
80	110	16	36 400	39 000	1 660	16	11 000	18 000	0,37	71916 CD
	110	16	21 200	20 800	880	11	15 000	24 000	0,36	71916 CE
	110	16	34 500	36 500	1 560	–	9 500	16 000	0,37	71916 ACD
	125	22	65 000	61 000	2 550	16	10 000	17 000	0,85	7016 CD
	125	22	34 500	30 500	1 270	11	14 000	22 000	0,82	7016 CE
	125	22	62 400	58 500	2 450	–	9 000	15 000	0,85	7016 ACD
140	26	97 500	81 500	3 350	15	9 500	16 000	1,45	7216 CD	
	26	92 300	78 000	3 200	–	8 500	14 000	1,45	7216 ACD	
85	120	18	46 200	48 000	2 040	16	10 000	17 000	0,53	71917 CD
	120	18	43 600	45 500	1 930	–	9 000	15 000	0,53	71917 ACD
	130	22	67 600	65 500	2 650	16	9 500	16 000	0,89	7017 CD
	130	22	63 700	62 000	2 500	–	8 500	14 000	0,89	7017 ACD
150	28	99 500	88 000	3 450	15	9 000	15 000	1,80	7217 CD	
	28	95 600	85 000	3 350	–	8 000	13 000	1,80	7217 ACD	
90	125	18	47 500	51 000	2 080	16	9 500	16 000	0,55	71918 CD
	125	18	29 100	29 000	1 180	11	13 000	20 000	0,53	71918 CE
	125	18	44 200	48 000	1 960	–	8 500	14 000	0,55	71918 ACD
	140	24	79 300	76 500	3 000	16	9 000	15 000	1,15	7018 CD
	140	24	44 200	40 000	1 560	11	12 000	19 000	1,10	7018 CE
	140	24	74 100	72 000	2 850	–	8 000	13 000	1,15	7018 ACD
160	30	127 000	112 000	4 250	15	8 500	14 000	2,25	7218 CD	
	30	121 000	106 000	4 050	–	7 500	12 000	2,25	7218 ACD	
95	130	18	49 400	55 000	2 200	16	9 000	15 000	0,58	71919 CD
	130	18	46 200	52 000	2 080	–	8 500	14 000	0,58	71919 ACD
	145	24	81 900	80 000	3 100	16	8 500	14 000	1,20	7019 CD
	145	24	76 100	76 500	2 900	–	8 000	13 000	1,20	7019 ACD
170	32	138 000	120 000	4 400	15	8 000	13 000	2,70	7219 CD	
	32	133 000	114 000	4 250	–	7 500	12 000	2,70	7219 ACD	

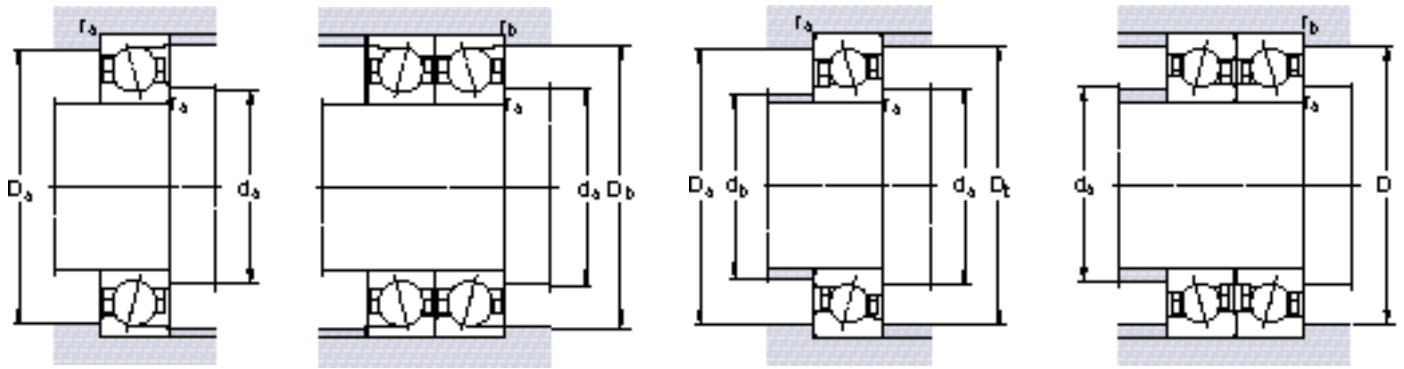

Dimensions

Abutment and fillet dimensions

d	d ₁ ≈	D ₁ ≈	r _{1,2} min	r _{3,4} min	a	d _a min	d _b min	D _a max	D _b max	r _a max	r _b max
mm						mm					
75	84,3	95,7	1	0,3	20	81	–	99	102	1	0,3
	84,3	95,7	1	0,3	29	81	–	99	102	1	0,3
	87,9	103	1,1	0,6	23	82	–	108	111	1	0,6
	87,9	103	1,1	0,6	32	82	–	108	111	1	0,6
	92	113	1,5	0,6	26	84	–	121	125	1,5	0,6
	92	113	1,5	0,6	37	84	–	121	125	1,5	0,6
80	89,3	101	1	0,3	21	86	–	104	108	1	0,3
	90,2	99,8	1	0,3	21	86	83	104	108	1	0,3
	89,3	101	1	0,3	30	86	–	104	108	1	0,3
	94,4	111	1,1	0,6	25	87	–	118	121	1	0,6
	95,8	109,2	1,1	0,6	25	87	84	118	121	1	0,6
	94,4	111	1,1	0,6	35	87	–	118	121	1	0,6
	98,6	122	2	1	28	90	–	130	134	2	1
	98,6	122	2	1	39	90	–	130	134	2	1
85	95,8	110	1,1	0,6	23	92	–	113	115	1	0,6
	95,8	110	1,1	0,6	33	92	–	113	115	1	0,6
	99,4	116	1,1	0,6	26	92	–	123	125	1	0,6
	99,4	116	1,1	0,6	36	92	–	123	125	1	0,6
	106	130	1,2	1	30	95	–	140	144	2	1
	106	130	1,2	1	42	95	–	140	144	2	1
90	100	115	1,1	0,6	23	97	–	118	120	1	0,6
	101,7	113,3	1,1	0,6	24	97	95	118	120	1	0,6
	100	115	1,1	0,6	34	97	–	118	120	1	0,6
	106	124	1,5	0,6	28	99	–	131	135	1,5	0,6
	107,3	122,7	1,5	0,6	28	99	95	131	135	1,5	0,6
	106	124	1,5	0,6	39	99	–	131	135	1,5	0,6
	111	139	2	1	32	100	–	150	154	2	1
	111	139	2	1	44	100	–	150	154	2	1
95	105	120	1,1	0,6	24	102	–	123	125	1	0,6
	105	120	1,1	0,6	35	102	–	123	125	1	0,6
	111	129	1,5	0,6	28	104	–	136	140	1,5	0,6
	111	129	1,5	0,6	40	104	–	136	140	1,5	0,6
	118	147	2,1	1,1	34	107	–	158	163	2	1
	118	147	2,1	1,1	47	107	–	158	163	2	1

Precision angular contact ball bearings
d 100 – 140 mm

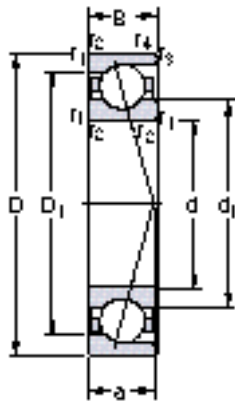

CD, ACD

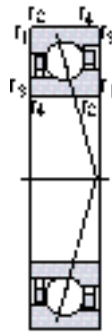

CE

Principal dimensions			Basic load ratings		Fatigue load limit P_u	Calculation factor f_0	Speed ratings		Mass	Designation
d	D	B	C	C_0			Lubrication grease	oil spot		
mm			N		N	–	r/min	kg	–	
100	140	20	60 500	65 500	2 550	16	8 500	14 000	0,80	71920 CD
	140	20	57 200	63 000	2 400	–	8 000	13 000	0,80	71920 ACD
	150	24	83 200	85 000	3 200	16	8 500	14 000	1,25	7020 CD
	150	24	46 200	43 000	1 630	11	10 000	17 000	1,20	7020 CE
	150	24	79 300	80 000	3 050	–	7 500	12 000	1,25	7020 ACD
	180	34	156 000	137 000	4 900	15	7 500	12 000	3,25	7220 CD
	180	34	148 000	129 000	4 650	–	7 000	11 000	3,25	7220 ACD
105	145	20	61 800	69 500	2 600	16	8 500	14 000	0,82	71921 CD
	145	20	57 200	65 500	2 500	–	7 500	12 000	0,82	71921 ACD
	160	26	95 600	96 500	3 600	16	8 000	13 000	1,60	7021 CD
	160	26	90 400	93 000	3 400	–	7 500	12 000	1,60	7021 ACD
	190	36	172 000	153 000	5 300	15	7 500	12 000	3,85	7221 CD
	190	36	163 000	146 000	5 100	–	6 700	10 000	3,85	7221 ACD
110	150	20	62 400	72 000	2 700	17	8 000	13 000	0,86	71922 CD
	150	20	58 500	68 000	2 550	–	7 500	12 000	0,86	71922 ACD
	170	28	111 000	108 000	3 900	16	7 500	12 000	1,95	7022 CD
	170	28	104 000	104 000	3 750	–	7 000	11 000	1,95	7022 ACD
	200	38	178 000	166 000	5 600	15	7 000	11 000	4,55	7222 CD
	200	38	168 000	160 000	5 400	–	6 700	10 000	4,55	7222 ACD
120	165	22	78 000	91 500	3 250	16	7 500	12 000	1,15	71924 CD
	165	22	72 800	86 500	3 050	–	7 000	11 000	1,15	71924 ACD
	180	28	114 000	122 000	4 250	16	7 000	11 000	2,10	7024 CD
	180	28	111 000	116 000	4 000	–	6 700	10 000	2,10	7024 ACD
	215	40	199 000	193 000	6 300	15	6 700	10 000	5,40	7224 CD
	215	40	190 000	183 000	6 000	–	6 000	9 000	5,40	7224 ACD
130	180	24	92 300	108 000	3 650	16	7 000	11 000	1,55	71926 CD
	180	24	87 100	102 000	3 450	–	6 700	10 000	1,55	71926 ACD
	200	33	148 000	156 000	5 200	16	6 700	10 000	3,20	7026 CD
	200	33	140 000	150 000	4 900	–	6 000	9 000	3,20	7026 ACD
140	190	24	95 600	116 000	3 900	17	6 700	10 000	1,65	71928 CD
	190	24	90 400	110 000	3 650	–	6 000	9 000	1,65	71928 ACD
	210	33	153 000	166 000	5 300	16	6 700	10 000	3,40	7028 CD
	210	33	146 000	156 000	5 100	–	5 600	8 500	3,40	7028 ACD

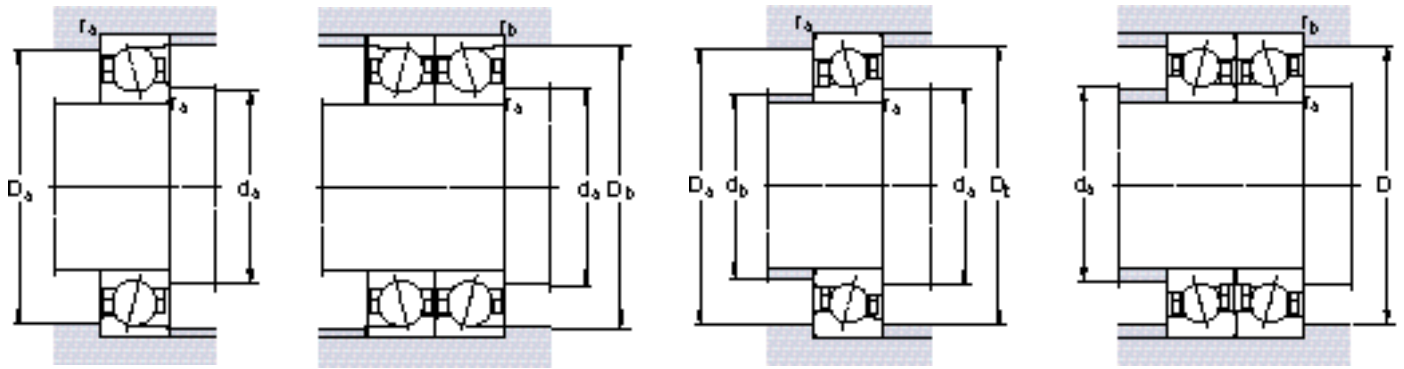

Dimensions

Abutment and fillet dimensions

d	d ₁ ≈	D ₁ ≈	r _{1,2} min	r _{3,4} min	a	d _a min	d _b min	D _a max	D _b max	r _a max	r _b max
mm						mm					
100	112	128	1,1	0,6	26	107	–	133	135	1	0,6
	112	128	1,1	0,6	38	107	–	133	135	1	0,6
	116	134	1,5	0,6	29	109	–	141	145	1,5	0,6
	117,3	132,7	1,5	0,6	29	109	105	141	145	1,5	0,6
	116	134	1,5	0,6	41	109	–	141	145	1,5	0,6
	124	155	2,1	1,1	36	112	–	168	173	2	1
	124	155	2,1	1,1	50	112	–	168	173	2	1
105	117	133	1,1	0,6	27	112	–	138	140	1	0,6
	117	133	1,1	0,6	39	112	–	138	140	1	0,6
	122	143	2	1	31	115	–	150	154	2	1
	122	143	2	1	44	115	–	150	154	2	1
	131	164	2,1	1,1	38	117	–	178	183	2	1
	131	164	2,1	1,1	53	117	–	178	183	2	1
110	122	138	1,1	0,6	27	117	–	143	145	1	0,6
	122	138	1,1	0,6	40	117	–	143	145	1	0,6
	129	151	2	1	33	120	–	160	164	2	1
	129	151	2	1	47	120	–	160	164	2	1
	138	172	2,1	1,1	40	122	–	188	193	2	1
	138	172	2,1	1,1	55	122	–	188	193	2	1
120	133	152	1,1	0,6	30	127	–	158	160	1	0,6
	133	152	1,1	0,6	44	127	–	158	160	1	0,6
	139	161	2	1	34	130	–	170	174	2	1
	139	161	2	1	49	130	–	170	174	2	1
	150	187	2,1	1,1	43	132	–	203	208	2	1
	150	187	2,1	1,1	60	132	–	203	208	2	1
130	145	165	1,5	0,6	33	139	–	171	175	1,5	0,6
	145	165	1,5	0,6	48	139	–	171	175	1,5	0,6
	152	178	2	1	39	140	–	190	194	2	1
	152	178	2	1	55	140	–	190	194	2	1
140	155	175	1,5	0,6	34	149	–	181	185	1,5	0,6
	155	175	1,5	0,6	51	149	–	181	185	1,5	0,6
	162	188	2	1	40	150	–	200	204	2	1
	162	188	2	1	58	150	–	200	204	2	1

Precision angular contact ball bearings

d 150 – 240 mm

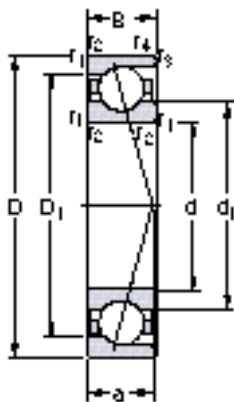

CD, ACD

Principal dimensions			Basic load ratings		Fatigue load limit P_u	Calculation factor f_0	Speed ratings		Mass	Designation
d	D	B	C	C_0			Lubrication grease	oil spot		
mm			N		N	–	r/min		kg	–
150	210	28	125 000	146 000	4 750	16	6 300	9 500	2,55	71930 CD
	210	28	119 000	140 000	4 500	–	5 000	8 500	2,55	71930 ACD
	225	35	172 000	190 000	5 850	16	6 000	9 000	4,15	7030 CD
	225	35	163 000	180 000	5 600	–	5 300	8 000	4,15	7030 ACD
160	220	28	130 000	160 000	5 000	16	6 000	9 000	2,70	71932 CD
	220	28	124 000	153 000	4 750	–	5 600	8 500	2,70	71932 ACD
	240	38	195 000	216 000	6 550	16	5 600	8 500	5,10	7032 CD
	240	38	182 000	204 000	6 200	–	5 000	7 500	5,10	7032 ACD
170	230	28	133 000	166 000	5 100	16	5 600	8 500	2,85	71934 CD
	230	28	124 000	160 000	4 800	–	5 000	7 500	2,85	71934 ACD
	260	42	212 000	245 000	7 100	16	5 300	8 000	6,85	7034 CD
	260	42	199 000	232 000	6 700	–	4 800	7 000	6,85	7034 ACD
180	250	33	168 000	212 000	6 100	16	5 300	8 000	4,20	71936 CD
	250	33	159 000	200 000	5 850	–	4 800	7 000	4,20	71936 ACD
	280	46	242 000	290 000	8 150	16	5 000	7 500	8,90	7036 CD
	280	46	229 000	275 000	7 650	–	4 300	6 300	8,90	7036 ACD
190	260	33	172 000	220 000	6 200	16	5 000	7 500	4,35	71938 CD
	260	33	163 000	208 000	5 850	–	4 500	6 700	4,35	71938 ACD
	290	46	247 000	300 000	8 300	16	4 800	7 000	9,35	7038 CD
	290	46	234 000	290 000	8 000	–	4 300	6 300	9,35	7038 ACD
200	280	38	208 000	265 000	7 200	16	4 800	7 000	6,10	71940 CD
	280	38	199 000	250 000	6 800	–	4 300	6 300	6,10	71940 ACD
	310	51	296 000	390 000	10 200	16	4 500	6 700	12,0	7040 CD
	310	51	281 000	365 000	9 800	–	4 000	6 000	12,0	7040 ACD
220	300	38	221 000	300 000	7 800	16	4 300	6 300	6,60	71944 CD
	300	38	208 000	285 000	7 500	–	3 800	5 600	6,60	71944 ACD
	340	56	338 000	455 000	11 600	16	4 000	6 000	16,0	7044 CD
	340	56	319 000	440 000	11 000	–	3 600	5 300	16,0	7044 ACD
240	320	38	225 000	310 000	8 000	17	4 000	6 000	8,50	71948 CD
	320	38	212 000	300 000	7 500	–	3 600	5 300	8,50	71948 ACD
	360	56	345 000	490 000	12 000	16	3 800	5 600	17,0	7048 CD
	360	56	325 000	465 000	11 400	–	3 200	4 800	17,0	7048 ACD

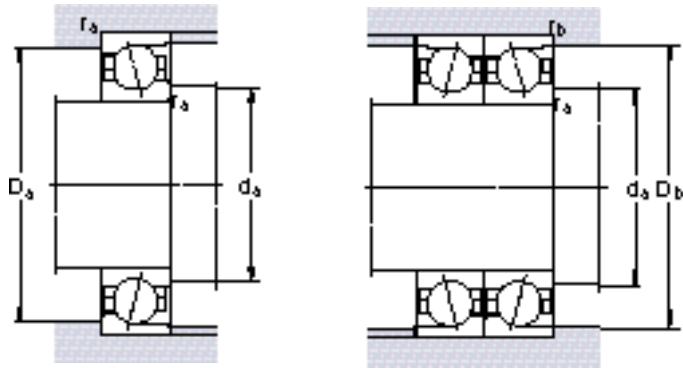

Dimensions

Abutment and fillet dimensions

d	d ₁ ≈	D ₁ ≈	r _{1,2} min	r _{3,4} min	a	d _a min	D _a max	D _b max	r _a max	r _b max
mm	mm									
150	168	192	2	1	38	160	200	204	2	1
	168	192	2	1	56	160	200	204	2	1
	174	201	2,1	1	43	162	213	219	2	1
	174	201	2,1	1	62	162	213	219	2	1
160	178	202	2	1	40	170	210	214	2	1
	178	202	2	1	58	170	210	214	2	1
	185	215	2,1	1	46	172	228	234	2	1
	185	215	2,1	1	66	172	228	234	2	1
170	188	212	2	1	41	180	220	224	2	1
	188	212	2	1	61	180	220	224	2	1
	199	231	2,1	1,1	50	182	248	253	2	1
	199	231	2,1	1,1	71	182	248	253	2	1
180	201	229	2	1	45	190	240	244	2	1
	201	229	2	1	67	190	240	244	2	1
	212	248	2,1	1,1	54	192	268	273	2	1
	212	248	2,1	1,1	77	192	268	273	2	1
190	211	239	2	1	47	200	250	254	2	1
	211	239	2	1	69	200	250	254	2	1
	222	258	2,1	1,1	55	202	278	283	2	1
	222	258	2,1	1,1	79	202	278	283	2	1
200	224	256	2,1	1	51	212	268	274	2	1
	224	256	2,1	1	75	212	268	274	2	1
	234	276	2,1	1,1	60	212	298	303	2	1
	234	276	2,1	1,1	85	212	298	303	2	1
220	244	276	2,1	1	54	232	288	294	2	1
	244	276	2,1	1	80	232	288	294	2	1
	258	302	3	1,1	66	234	326	333	2,5	1
	258	302	3	1,1	94	234	326	333	2,5	1
240	267	295	2,1	1,1	57	252	308	313	2	1
	267	295	2,1	1,1	84	252	308	313	2	1
	278	322	3	1,1	68	254	346	353	2,5	1
	278	322	3	1,1	98	254	346	353	2,5	1

Hybrid precision angular contact ball bearings

d 8 – 20 mm

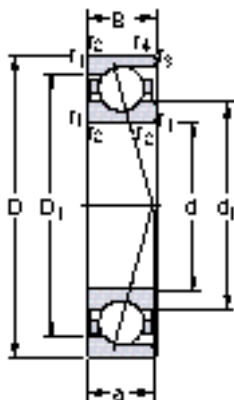

CD/HC, ACD/HC

Principal dimensions			Basic load ratings		Fatigue load limit P_u	Calculation factor f_0	Speed ratings		Mass	Designation
d	D	B	C	C_0			Lubrication grease	oil spot		
mm			N		N	–	r/min		kg	–
8	22	7	2 960	1 160	49	8,4	80 000	120 000	0,010	708 CD/HC
	22	7	2 910	1 120	48	–	75 000	110 000	0,010	708 ACD/HC
9	24	7	3 250	1 340	57	8,8	80 000	120 000	0,012	709 CD/HC
	24	7	3 120	1 290	54	–	75 000	110 000	0,012	709 ACD/HC
10	22	6	2 510	1 100	48	9,5	80 000	120 000	0,0080	71900 CD/HC
	22	6	2 420	1 060	45	–	75 000	110 000	0,0080	71900 ACD/HC
	26	8	4 100	1 660	71	8,3	75 000	110 000	0,016	7000 CD/HC
	26	8	3 970	1 600	67	–	70 000	100 000	0,016	7000 ACD/HC
	30	9	5 400	2 200	93	8,2	70 000	100 000	0,025	7200 CD/HC
	30	9	5 200	2 120	90	–	67 000	95 000	0,025	7200 ACD/HC
12	24	6	2 650	1 250	53	9,8	75 000	110 000	0,0090	71901 CD/HC
	24	6	2 550	1 180	50	–	70 000	100 000	0,0090	71901 ACD/HC
	28	8	4 490	1 900	80	8,7	70 000	100 000	0,017	7001 CD/HC
	28	8	4 360	1 830	78	–	67 000	95 000	0,017	7001 ACD/HC
	32	10	5 850	2 550	108	8,5	67 000	95 000	0,032	7201 CD/HC
	32	10	5 720	2 450	104	–	60 000	85 000	0,032	7201 ACD/HC
15	28	7	3 970	1 900	80	9,6	67 000	95 000	0,013	71902 CD/HC
	28	7	3 770	1 800	78	–	63 000	90 000	0,013	71902 ACD/HC
	32	9	5 200	2 450	104	9,3	63 000	90 000	0,025	7002 CD/HC
	32	9	4 940	2 320	98	–	56 000	80 000	0,025	7002 ACD/HC
	35	11	7 410	3 350	140	8,5	60 000	85 000	0,037	7202 CD/HC
	35	11	7 150	3 200	134	–	53 000	75 000	0,037	7202 ACD/HC
17	30	7	4 160	2 080	88	9,8	63 000	90 000	0,015	71903 CD/HC
	30	7	3 970	2 000	85	–	56 000	80 000	0,015	71903 ACD/HC
	35	10	6 760	3 250	137	9,1	56 000	80 000	0,032	7003 CD/HC
	35	10	6 500	3 100	132	–	53 000	75 000	0,032	7003 ACD/HC
	40	12	9 230	4 150	176	8,5	43 000	63 000	0,062	7203 CD/HC
	40	12	8 840	4 000	170	–	38 000	56 000	0,062	7203 ACD/HC
20	37	9	6 050	3 200	137	9,8	53 000	75 000	0,031	71904 CD/HC
	37	9	5 720	3 050	129	–	48 000	67 000	0,031	71904 ACD/HC
	42	12	8 710	4 300	180	9,2	48 000	67 000	0,058	7004 CD/HC
	42	12	8 320	4 150	173	–	43 000	60 000	0,058	7004 ACD/HC
	47	14	11 900	5 850	245	8,7	43 000	60 000	0,089	7204 CD/HC
	47	14	11 400	5 600	236	–	40 000	56 000	0,089	7204 ACD/HC

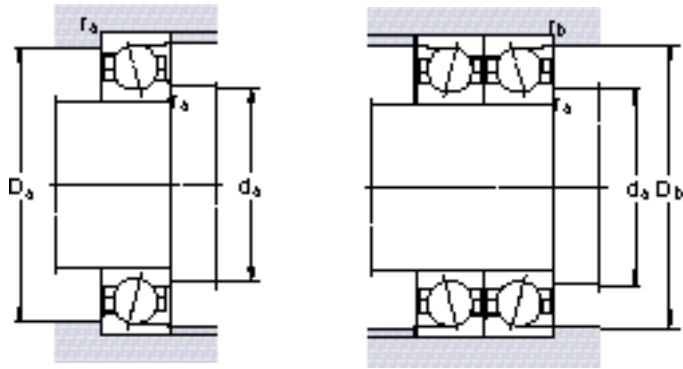

Dimensions

Abutment and fillet dimensions

d	d ₁ ≈	D ₁ ≈	r _{1,2} min	r _{3,4} min	a	d _a min	D _a max	D _b max	r _a max	r _b max
mm	mm									
8	12,6	17,7	0,3	0,1	6	10	20	20,4	0,3	0,1
	12,6	17,5	0,3	0,1	7	10	20	20,4	0,3	0,1
9	13,9	19,5	0,3	0,1	6	11	22	22,4	0,3	0,1
	13,9	19,2	0,3	0,1	7	11	22	22,4	0,3	0,1
10	13,9	18,1	0,3	0,1	5	12	20	20,8	0,3	0,1
	13,9	18,1	0,3	0,1	7	12	20	20,8	0,3	0,1
	15,1	21,3	0,3	0,1	6	12	24	24,4	0,3	0,1
	15,1	21	0,3	0,1	8	12	24	24,4	0,3	0,1
12	16,8	23,3	0,6	0,3	7	15	25	28	0,6	0,3
	16,8	23,3	0,6	0,3	9	15	25	28	0,6	0,3
	15,9	20,1	0,3	0,1	5	14	22	22,8	0,3	0,1
	15,9	20,1	0,3	0,1	7	14	22	22,8	0,3	0,1
15	17,1	23,3	0,3	0,1	7	14	26	26,4	0,3	0,1
	17,1	23	0,3	0,1	9	14	26	26,4	0,3	0,1
	18,2	25,8	0,6	0,3	8	17	27	30	0,6	0,3
	18,2	25,8	0,6	0,3	10	17	27	30	0,6	0,3
17	19,1	23,9	0,3	0,1	6	17	26	26,8	0,3	0,1
	19,1	23,9	0,3	0,1	9	17	26	26,8	0,3	0,1
	20,6	26,8	0,3	0,1	8	17	30	30,4	0,3	0,1
	20,6	26,5	0,3	0,1	10	17	30	30,4	0,3	0,1
20	21,5	29,1	0,6	0,3	9	20	30	33	0,6	0,3
	21,5	29,1	0,6	0,3	12	20	30	33	0,6	0,3
	21,1	25,9	0,3	0,1	7	19	28	28,8	0,3	0,1
	21,1	25,9	0,3	0,1	9	19	28	28,8	0,3	0,1
17	22,9	29,6	0,3	0,1	9	19	33	33,4	0,3	0,1
	22,9	29,2	0,3	0,1	11	19	33	33,4	0,3	0,1
	24,2	32,8	0,6	0,3	10	22	35	38	0,6	0,3
	24,2	32,8	0,6	0,3	13	22	35	38	0,6	0,3
20	25,4	31,6	0,3	0,15	8	22	35	35,8	0,3	0,1
	25,4	31,6	0,3	0,15	11	22	35	35,8	0,3	0,1
	26,9	35,1	0,6	0,3	10	25	37	40	0,6	0,3
	26,9	35,1	0,6	0,3	13	25	37	40	0,6	0,3
20	29,1	38,7	1	0,3	12	26	41	45	1	0,3
	29,1	38,7	1	0,3	15	26	41	45	1	0,3

Hybrid precision angular contact ball bearings

d 25 – 45 mm

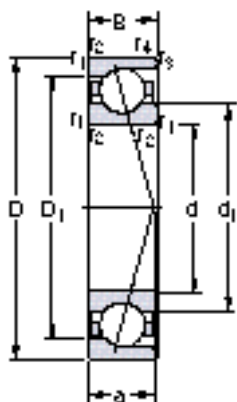

CD/HC, ACD/HC

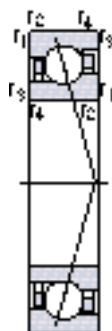

CE/HC

Principal dimensions			Basic load ratings		Fatigue load limit P_u	Calculation factor f_0	Speed ratings		Mass	Designation
d	D	B	C	C_0			Lubrication grease	oil spot		
mm			N		N	–	r/min	kg	–	
25	42	9	6 760	4 000	170	10	45 000	63 000	0,037	71905 CD/HC
	42	9	6 370	3 800	160	–	40 000	56 000	0,037	71905 ACD/HC
25	47	12	9 560	5 200	220	9,6	40 000	56 000	0,066	7005 CD/HC
	47	12	8 710	4 550	193	8,4	50 000	70 000	0,067	7005 CE/HC
	47	12	9 230	5 000	212	–	38 000	53 000	0,066	7005 ACD/HC
25	52	15	13 500	7 200	305	9,1	38 000	53 000	0,12	7205 CD/HC
	52	15	13 000	6 950	290	–	34 000	48 000	0,12	7205 ACD/HC
30	47	9	7 150	4 550	193	10	38 000	53 000	0,043	71906 CD/HC
	47	9	6 760	4 300	183	–	34 000	48 000	0,043	71906 ACD/HC
30	55	13	14 300	8 000	345	9,4	34 000	48 000	0,094	7006 CD/HC
	55	13	13 000	6 950	300	8,2	43 000	60 000	0,094	7006 CE/HC
	55	13	13 800	7 650	325	–	32 000	45 000	0,094	7006 ACD/HC
30	62	16	24 200	16 000	670	14	32 000	45 000	0,17	7206 CD/HC
	62	16	23 400	15 300	640	–	28 000	40 000	0,17	7206 ACD/HC
35	55	10	9 750	6 550	275	10	32 000	45 000	0,065	71907 CD/HC
	55	10	9 230	6 200	260	–	30 000	43 000	0,065	71907 ACD/HC
35	62	14	15 600	9 500	400	9,7	30 000	43 000	0,13	7007 CD/HC
	62	14	14 000	8 300	355	8,5	38 000	50 000	0,13	7007 CE/HC
	62	14	14 800	9 000	380	–	26 000	38 000	0,13	7007 ACD/HC
35	72	17	31 900	21 600	915	14	26 000	38 000	0,24	7207 CD/HC
	72	17	30 700	20 800	880	–	22 000	34 000	0,24	7207 ACD/HC
40	62	12	12 400	8 500	360	10	28 000	40 000	0,096	71908 CD/HC
	62	12	11 700	8 000	340	–	24 000	36 000	0,096	71908 ACD/HC
40	68	15	16 800	11 000	465	10	26 000	38 000	0,16	7008 CD/HC
	68	15	15 100	9 500	405	8,7	34 000	48 000	0,16	7008 CE/HC
	68	15	15 900	10 400	440	–	22 000	34 000	0,16	7008 ACD/HC
40	80	18	41 000	28 000	1 180	14	22 000	34 000	0,30	7208 CD/HC
	80	18	39 000	27 000	1 140	–	20 000	32 000	0,30	7208 ACD/HC
45	68	12	13 000	9 500	400	11	24 000	36 000	0,11	71909 CD/HC
	68	12	12 400	9 000	380	–	22 000	34 000	0,11	71909 ACD/HC
45	75	16	28 600	22 400	950	15	22 000	34 000	0,20	7009 CD/HC
	75	16	27 600	21 600	900	–	20 000	32 000	0,20	7009 ACD/HC
45	85	19	42 300	31 000	1 320	14	20 000	32 000	0,34	7209 CD/HC
	85	19	41 000	30 000	1 250	–	18 000	28 000	0,34	7209 ACD/HC

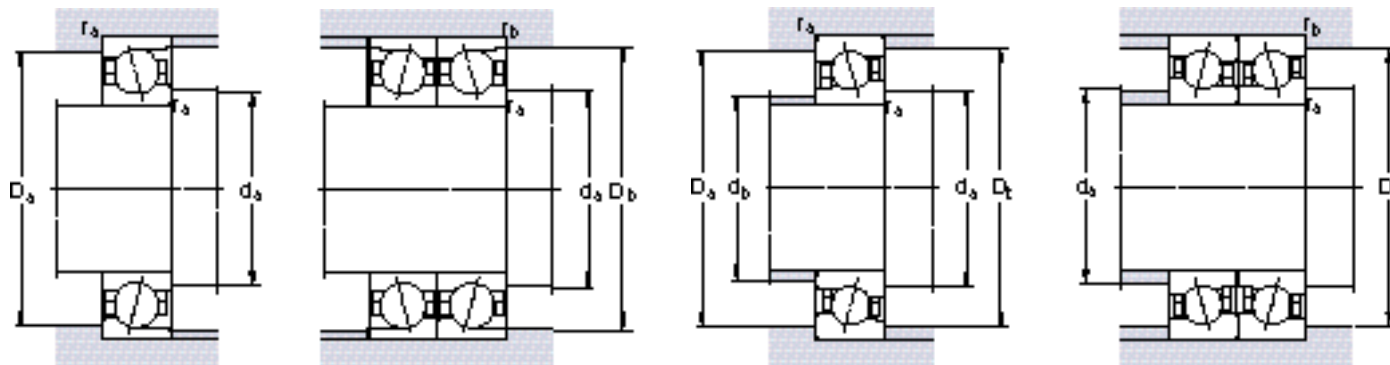

Dimensions

Abutment and fillet dimensions

d	d ₁ ≈	D ₁ ≈	r _{1,2} min	r _{3,4} min	a	d _a min	d _b min	D _a max	D _b max	r _a max	r _b max
mm	mm										
25	30,4	36,6	0,3	0,15	9	27	–	40	40,8	0,3	0,1
	30,4	36,6	0,3	0,15	12	27	–	40	40,8	0,3	0,1
	31,9	40,1	0,6	0,3	11	30	–	42	45	0,6	0,3
	32,2	39,9	0,6	0,3	11	30	27	42	45	0,3	–
	31,9	40,1	0,6	0,3	15	30	–	42	45	0,6	0,3
30	34,1	43,7	1	0,3	13	31	–	46	50	1	0,3
	34,1	43,7	1	0,3	17	31	–	46	50	1	0,3
	35,4	41,6	0,3	0,15	10	32	–	45	45,8	0,3	0,1
	35,4	41,6	0,3	0,15	14	32	–	45	45,8	0,3	0,1
	38,1	46,9	1	0,3	12	36	–	49	53	1	0,3
35	37,7	47,3	1	0,3	12	36	32	49	53	1	0,3
	38,1	46,9	1	0,3	17	36	–	49	53	1	0,3
	40,3	51,7	1	0,3	14	36	–	56	60	1	0,3
	40,3	51,7	1	0,3	19	36	–	56	60	1	0,3
	41,2	48,8	0,6	0,15	11	40	–	50	53,8	0,6	0,1
40	41,2	48,8	0,6	0,15	16	40	–	50	53,8	0,6	0,1
	43,7	53,3	1	0,3	14	41	–	56	60	1	0,3
	43,7	53,3	1	0,3	14	41	37	56	60	1	0,3
	43,7	53,3	1	0,3	19	41	–	56	60	1	0,3
	47	60	1,1	0,3	16	42	–	65	70	1	0,3
45	47	60	1,1	0,3	21	42	–	65	70	1	0,3
	46,7	55,3	0,6	0,15	13	45	–	57	60,8	0,6	0,1
	46,7	55,3	0,6	0,15	18	45	–	57	60,8	0,6	0,1
	49,2	58,8	1	0,3	15	46	–	62	66	1	0,3
	49,2	58,8	1	0,3	15	46	42	62	66	1	0,3
50	49,2	58,8	1	0,3	20	46	–	62	66	1	0,3
	53	67	1,1	0,6	17	47	–	73	75	1	0,6
	53	67	1,1	0,6	23	47	–	73	75	1	0,6
	52,2	60,8	0,6	0,15	14	50	–	63	66,8	0,6	0,1
	52,2	60,8	0,6	0,15	19	50	–	63	66,8	0,6	0,1
55	54,7	65,3	1	0,3	16	51	–	69	73	1	0,3
	54,7	65,3	1	0,3	22	51	–	69	73	1	0,3
	57,5	72,5	1,1	0,6	18	52	–	78	80	1	0,6
	57,5	72,5	1,1	0,6	25	52	–	78	80	1	0,6

Hybrid precision angular contact ball bearings

d 50 – 75 mm

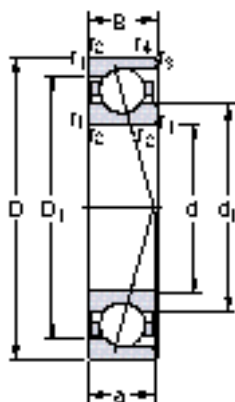

CD/HC, ACD/HC

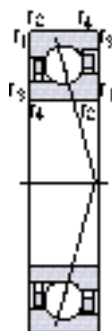

CE/HC

Principal dimensions			Basic load ratings		Fatigue load limit P_u	Calculation factor f_0	Speed ratings		Mass	Designation
d	D	B	C	C_0			Lubrication grease	oil spot		
mm			N		N	–	r/min		kg	–
50	72	12	13 500	10 400	440	11	22 000	34 000	0,11	71910 CD/HC
	72	12	12 700	9 800	415	–	19 000	30 000	0,11	71910 ACD/HC
80	80	16	29 600	24 000	1 020	15	20 000	32 000	0,21	7010 CD/HC
	80	16	22 500	16 000	680	10	28 000	40 000	0,21	7010 CE/HC
	80	16	28 100	23 200	980	–	18 000	28 000	0,21	7010 ACD/HC
90	90	20	44 900	34 000	1 430	15	19 000	30 000	0,38	7210 CD/HC
	90	20	42 300	32 500	1 390	–	17 000	26 000	0,38	7210 ACD/HC
55	80	13	19 500	14 600	620	10	19 000	3 0000	0,15	71911 CD/HC
	80	13	18 200	13 700	585	–	18 000	28 000	0,15	71911 ACD/HC
90	90	18	39 700	32 500	1 370	15	18 000	28 000	0,31	7011 CD/HC
	90	18	37 100	31 000	1 320	–	17 000	26 000	0,31	7011 ACD/HC
100	100	21	55 300	43 000	1 800	14	17 000	26 000	0,51	7211 CD/HC
	100	21	52 700	40 500	1 730	–	16 000	24 000	0,51	7211 ACD/HC
60	85	13	19 900	15 300	655	11	18 000	28 000	0,16	71912 CD/HC
	85	13	13 500	12 200	520	11	24 000	36 000	0,17	71912 CE/HC
	85	13	18 600	14 600	620	–	17 000	26 000	0,16	71912 ACD/HC
95	95	18	40 300	34 500	1 500	15	17 000	26 000	0,34	7012 CD/HC
	95	18	19 000	16 300	680	11	20 000	32 000	0,36	7012 CE/HC
	95	18	39 000	33 500	1 400	–	16 000	24 000	0,34	7012 ACD/HC
110	110	22	67 600	53 000	2 240	14	16 000	24 000	0,65	7212 CD/HC
	110	22	63 700	50 000	2 120	–	15 000	22 000	0,65	7212 ACD/HC
65	90	13	20 800	17 000	710	11	17 000	26 000	0,17	71913 CD/HC
	90	13	19 500	16 000	680	–	16 000	24 000	0,17	71913 ACD/HC
100	100	18	41 600	37 500	1 600	16	16 000	24 000	0,36	7013 CD/HC
	100	18	19 900	17 600	750	11	19 000	30 000	0,36	7013 CE/HC
	100	18	39 000	35 500	1 500	–	15 000	22 000	0,36	7013 ACD/HC
70	100	16	34 500	34 000	1 430	16	16 000	24 000	0,28	71914 CD/HC
	100	16	20 300	18 300	780	11	19 000	30 000	0,29	71914 CE/HC
	100	16	32 500	32 500	1 370	–	15 000	22 000	0,28	71914 ACD/HC
110	110	20	52 000	45 500	1 930	15	15 000	22 000	0,49	7014 CD/HC
	110	20	27 000	23 600	1 000	15	18 000	28 000	0,53	7014 CE/HC
	110	20	48 800	44 000	1 860	–	14 000	20 000	0,49	7014 ACD/HC
75	105	16	35 800	37 500	1 560	16	15 000	22 000	0,30	71915 CD/HC
	105	16	33 800	35 500	1 500	–	14 000	20 000	0,30	71915 ACD/HC
115	115	20	52 700	49 000	2 080	16	15 000	22 000	0,52	7015 CD/HC
	115	20	49 400	46 500	1 960	–	13 000	19 000	0,52	7015 ACD/HC

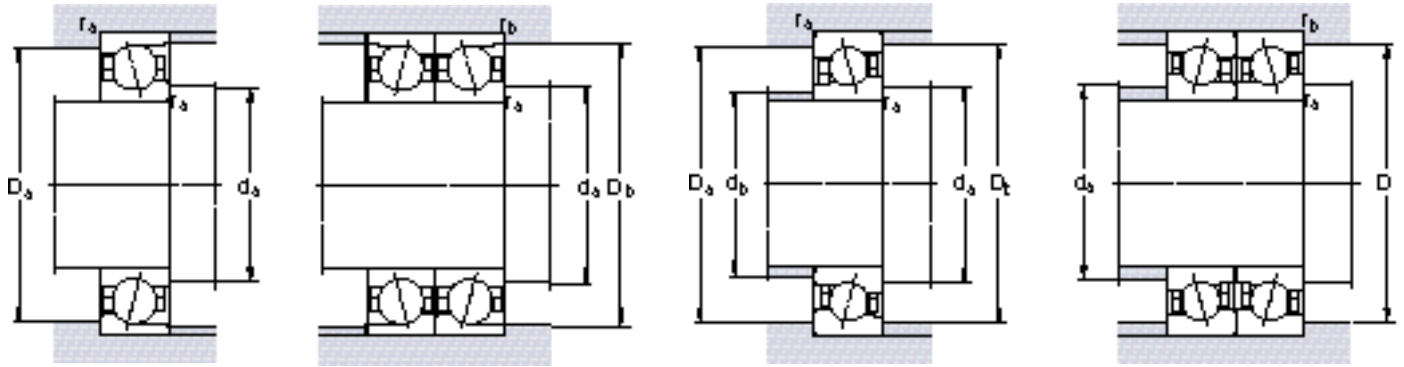

Dimensions

Abutment and fillet dimensions

d	d ₁ ≈	D ₁ ≈	r _{1,2} min	r _{3,4} min	a	d _a min	d _b min	D _a max	D _b max	r _a max	r _b max
mm	mm										
50	56,7	65,3	0,6	0,15	14	55	–	67	70,8	0,6	0,1
	56,7	65,3	0,6	0,15	20	55	–	67	70,8	0,6	0,1
	59,7	70,3	1	0,3	17	56	–	74	78	1	0,3
	59,3	70,8	1	0,3	17	56	54	74	78	1	0,3
	59,7	70,3	1	0,3	17	56	–	74	78	1	0,3
55	62,5	77,5	1,1	0,6	20	57	–	83	85	1	0,6
	62,5	77,5	1,1	0,6	27	57	–	83	85	1	0,6
	62,7	72,3	1	0,3	16	61	–	74	78	1	0,3
	62,7	72,3	1	0,3	22	61	–	74	78	1	0,3
	66,3	78,7	1,1	0,6	19	62	–	83	86	1	0,6
60	66,3	78,7	1,1	0,6	26	62	–	83	86	1	0,6
	69	85,9	1,5	0,6	21	64	–	91	95	1,5	0,6
	69	85,9	1,5	0,6	29	64	–	91	95	1,5	0,6
	67,7	77,3	1	0,3	16	66	–	79	82	1	0,3
	68,6	76,4	1	0,3	16	66	63	79	82	1	0,3
65	67,7	77,3	1	0,3	23	66	–	79	82	1	0,3
	71,3	83,7	1,1	0,6	20	67	–	88	91	1	0,6
	72,7	82,3	1,1	0,6	19	67	64	88	91	1	0,6
	71,3	83,7	1,1	0,6	27	67	–	88	91	1	0,6
	75,6	94,4	1,5	0,6	23	69	–	101	105	1,5	0,6
	75,6	94,4	1,5	0,6	31	69	–	101	105	1,5	0,6
	72,7	82,3	1	0,3	17	71	–	84	87	1	0,3
70	72,7	82,3	1	0,3	25	71	–	84	87	1	0,3
	76,3	88,7	1,1	0,6	20	72	–	93	96	1	0,6
	77,7	87,3	1,1	0,6	20	72	69	93	96	1	0,6
	76,3	88,7	1,1	0,6	28	72	–	93	96	1	0,6
	79,3	90,7	1	0,3	19	76	–	94	97	1	0,3
75	80,2	89,3	1	0,3	19	76	73	94	97	1	0,3
	79,3	90,7	1	0,3	28	76	–	94	97	1	0,3
	82,9	97,1	1,1	0,6	22	77	–	103	106	1	0,6
	84,2	95,8	1,1	0,6	22	77	74	103	106	1	0,6
	82,9	97,1	1,1	0,6	31	77	–	103	106	1	0,6
80	84,3	95,7	1	0,3	20	81	–	99	102	1	0,3
	84,3	95,7	1	0,3	29	81	–	99	102	1	0,3
	87,9	103	1,1	0,6	23	82	–	108	111	1	0,6
	87,9	103	1,1	0,6	32	82	–	108	111	1	0,6

Hybrid precision angular contact ball bearings

d 80 – 140 mm

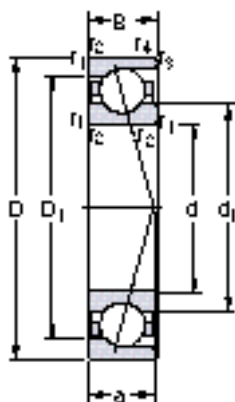

CD/HC, ACD/HC

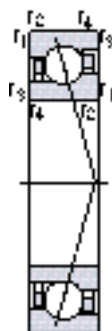

CE/HC

Principal dimensions			Basic load ratings		Fatigue load limit P_u	Calculation factor f_0	Speed ratings		Mass	Designation
d	D	B	C	C_0			Lubrication grease	oil spot		
mm			N		N	–	r/min		kg	–
80	110	16	36 400	39 000	1 660	16	15 000	22 000	0,31	71916 CD/HC
	110	16	21 200	20 800	880	11	17 000	26 000	0,32	71916 CE/HC
	110	16	34 500	36 500	1 560	–	13 000	19 000	0,31	71916 ACD/HC
	125	22	65 000	61 000	2 550	16	14 000	20 000	0,71	7016 CD/HC
	125	22	34 500	30 500	1 270	11	16 000	24 000	0,74	7016 CE/HC
	125	22	62 400	58 500	2 450	–	12 000	18 000	0,71	7016 ACD/HC
85	120	18	46 200	48 000	2 040	16	14 000	20 000	0,44	71917 CD/HC
	120	18	43 600	45 500	1 930	–	12 000	18 000	0,44	71917 ACD/HC
	130	22	67 600	65 500	2 650	16	13 000	19 000	0,74	7017 CD/HC
	130	22	63 700	62 000	2 500	–	11 000	17 000	0,74	7017 ACD/HC
90	125	18	47 500	51 000	2 080	16	13 000	19 000	0,47	71918 CD/HC
	125	18	29 100	29 000	1 180	11	16 000	24 000	0,47	71918 CE/HC
	125	18	44 200	48 000	1 960	–	11 000	17 000	0,47	71918 ACD/HC
	140	24	79 300	76 500	3 000	16	12 000	18 000	0,95	7018 CD/HC
	140	24	44 200	40 000	1 560	11	15 000	22 000	0,95	7018 CE/HC
	140	24	74 100	72 000	2 850	–	10 000	16 000	0,95	7018 ACD/HC
95	130	18	49 400	55 000	2 200	16	12 000	18 000	0,49	71919 CD/HC
	130	18	46 200	52 000	2 080	–	10 000	16 000	0,49	71919 ACD/HC
	145	24	81 900	80 000	3 100	16	11 000	17 000	1,00	7019 CD/HC
	145	24	76 100	76 500	2 900	–	9 500	15 000	1,00	7019 ACD/HC
100	140	20	60 500	65 500	2 550	16	11 000	17 000	0,66	71920 CD/HC
	140	20	57 200	63 000	2 400	–	9 500	15 000	0,66	71920 ACD/HC
	150	24	83 200	85 000	3 200	16	10 000	16 000	1,05	7020 CD/HC
	150	24	46 200	43 000	1 630	11	14 000	20 000	1,10	7020 CE/HC
	150	24	79 300	80 000	3 050	–	9 500	15 000	1,05	7020 ACD/HC
105	145	20	61 800	69 500	2 600	16	10 000	16 000	0,69	71921 CD/HC
	145	20	57 200	65 500	2 500	–	9 500	15 000	0,69	71921 ACD/HC
110	150	20	62 400	72 000	2 700	17	10 000	16 000	0,72	71922 CD/HC
	150	20	58 500	68 000	2 550	–	9 000	14 000	0,72	71922 ACD/HC
120	165	22	78 000	91 500	3 250	16	9 000	14 000	0,97	71924 CD/HC
	165	22	72 800	86 500	3 050	–	8 500	13 000	0,97	71924 ACD/HC
130	180	24	92 300	108 000	3 650	16	8 500	13 000	1,30	71926 CD/HC
	180	24	87 100	102 000	3 450	–	8 000	12 000	1,30	71926 ACD/HC
140	190	24	95 600	116 000	3 900	17	8 000	12 000	1,35	71928 CD/HC
	190	24	90 400	110 000	3 650	–	7 500	11 000	1,35	71928 ACD/HC

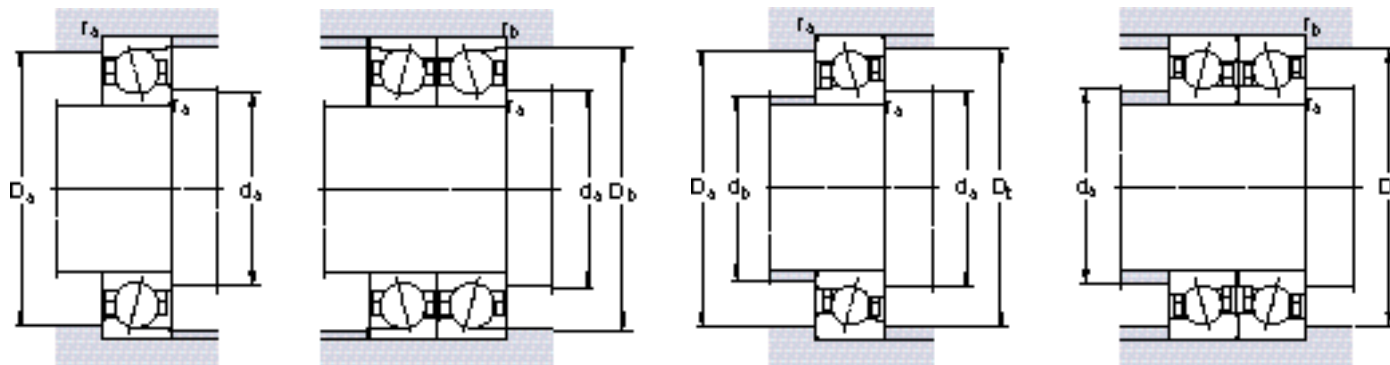

Dimensions

Abutment and fillet dimensions

d	d ₁ ≈	D ₁ ≈	r _{1,2} min	r _{3,4} min	a	d _a min	d _b min	D _a max	D _b max	r _a max	r _b max	
mm						mm						
80	89,3	101	1	0,3	21	86	—	104	108	1	0,3	
	90,2	99,8	1	0,3	21	86	83	104	108	1	0,3	
	89,3	101	1	0,3	30	86	—	104	108	1	0,3	
	94,4	111	1,1	0,6	25	87	—	118	121	1	0,6	
	95,8	109,2	1,1	0,6	25	87	84	118	121	1	0,6	
	94,4	111	1,1	0,6	35	87	—	118	121	1	0,6	
85	95,8	110	1,1	0,6	23	92	—	113	115	1	0,6	
	95,8	110	1,1	0,6	33	92	—	113	115	1	0,6	
	99,4	116	1,1	0,6	26	92	—	123	126	1	0,6	
	99,4	116	1,1	0,6	36	92	—	123	126	1	0,6	
	90	100	115	1,1	0,6	23	97	—	118	120	1	0,6
		101,7	113,3	1,1	0,6	24	97	95	118	120	1	0,6
100		115	1,1	0,6	34	97	—	118	120	1	0,6	
	106	124	1,5	0,6	28	99	—	131	135	1,5	0,6	
	107,3	122,7	1,5	0,6	28	99	95	131	135	1,5	0,6	
	106	124	1,5	0,6	39	99	—	131	135	1,5	0,6	
95	105	120	1,1	0,6	24	102	—	123	125	1	0,6	
	105	120	1,1	0,6	35	102	—	123	125	1	0,6	
	111	129	1,5	0,6	28	104	—	136	140	1,5	0,6	
	111	129	1,5	0,6	40	104	—	136	140	1,5	0,6	
	100	112	128	1,1	0,6	26	107	—	133	135	1	0,6
		112	128	1,1	0,6	38	107	—	133	135	1	0,6
116		134	1,5	0,6	29	109	—	141	145	1,5	0,6	
	117,3	132,7	1,5	0,6	29	109	105	141	145	1,5	0,6	
	116	134	1,5	0,6	41	109	—	141	145	1,5	0,6	
	105	117	133	1,1	0,6	27	112	—	138	140	1	0,6
117		133	1,1	0,6	39	112	—	138	140	1	0,6	
110		122	138	1,1	0,6	27	117	—	143	145	1	0,6
	122	138	1,1	0,6	40	117	—	143	145	1	0,6	
	120	133	152	1,1	0,6	30	127	—	158	160	1	0,6
133		152	1,1	0,6	44	127	—	158	160	1	0,6	
130		145	165	1,5	0,6	33	139	—	171	175	1,5	0,6
	145	165	1,5	0,6	48	139	—	171	175	1,5	0,6	
	140	155	175	1,5	0,6	34	149	—	181	185	1,5	0,6
155		175	1,5	0,6	51	149	—	181	185	1,5	0,6	

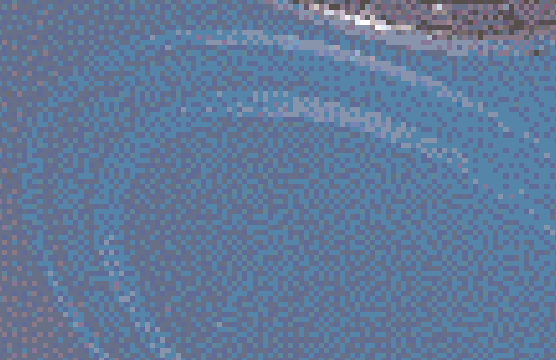
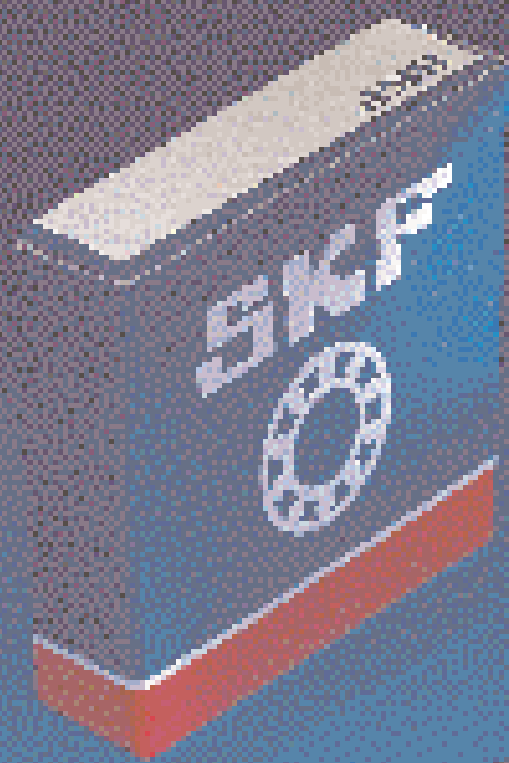

Cylindrical roller bearings

High precision cylindrical roller bearings are bearings with a low cross section, high load carrying capacity and little resilience. These properties make them particularly suitable for machine tool applications where spindle bearing arrangements are required to support heavy loads and have high stiffness. SKF produces double row as well as single row bearings.

Double row cylindrical roller bearings

Double row high precision cylindrical roller bearings are produced by SKF in the NN and NNU designs and in Dimension Series 30 and 49. The bearings of series NNU 49 have a particularly low cross section and give very stiff arrangements whereas those of series NN 30 have a somewhat higher cross section but can carry much heavier loads.

In bearings of the NN design (→ **fig 1**) the rollers are guided between integral flanges on the inner ring and in bearings of the NNU design (→ **fig 2**) between integral flanges in the outer ring. The other ring is without flanges. Axial displacement of the shaft relative to the housing in both directions can therefore take place, within certain limits, inside the bearings of

both designs. The bearings are separable, i.e. the ring with integral flanges and the roller and cage assemblies can be withdrawn from the other ring. This simplifies mounting and dismounting.

The bearings are produced with a cylindrical bore as well as with a tapered bore (taper 1:12); the bearings of series NN 30 normally have a tapered bore. Bearings with a tapered bore can be adjusted on mounting to a given radial clearance or preload.

In order to facilitate efficient lubrication, bearings of series NN 30 having a bore diameter of 50 mm and above and all bearings of series NNU 49 have an annular groove and three lubrication holes in the outer ring – the W33 feature.

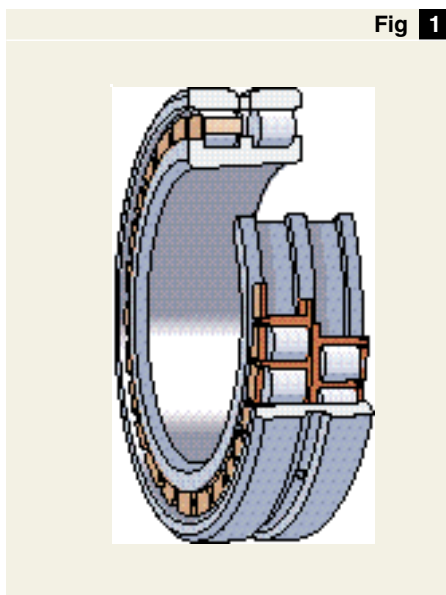

Fig 1

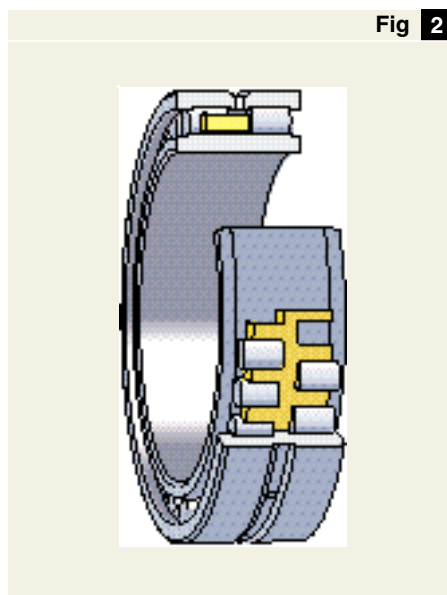
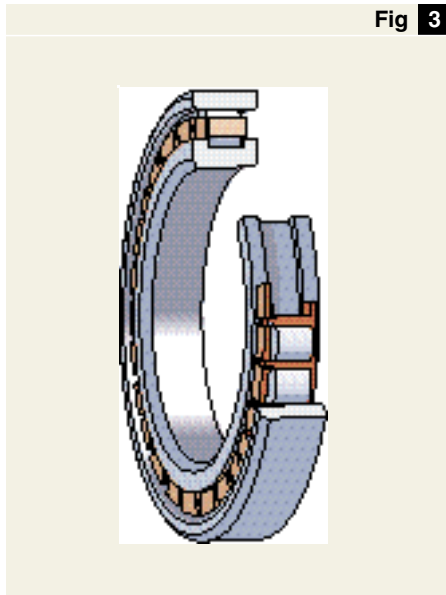

Fig 2

Fig 1
Cylindrical roller bearing, NN design

Fig 2
Cylindrical roller bearing, NNU design



Cylindrical roller bearing, N design

Single row cylindrical roller bearings

The single row high precision cylindrical roller bearings (→ fig 3) are designed for bearing arrangements where the high load carrying capacity of the double row cylindrical roller bearings is not required. They belong to Dimension Series 10 which has the same diameters as the NN 30 bearings. They are produced exclusively with a tapered bore (taper 1:12) and the series is designated N 10 K.

The rollers of these single row bearings are guided between two integral flanges on the inner ring. The outer ring is without flanges. Axial displacement of the shaft relative to the housing in both directions can therefore take place, within certain limits, inside the bearing itself. The bearings are also separable, i.e. the inner ring with integral flanges and the roller and cage assembly can be withdrawn from the outer ring. This facilitates mounting and dismounting.

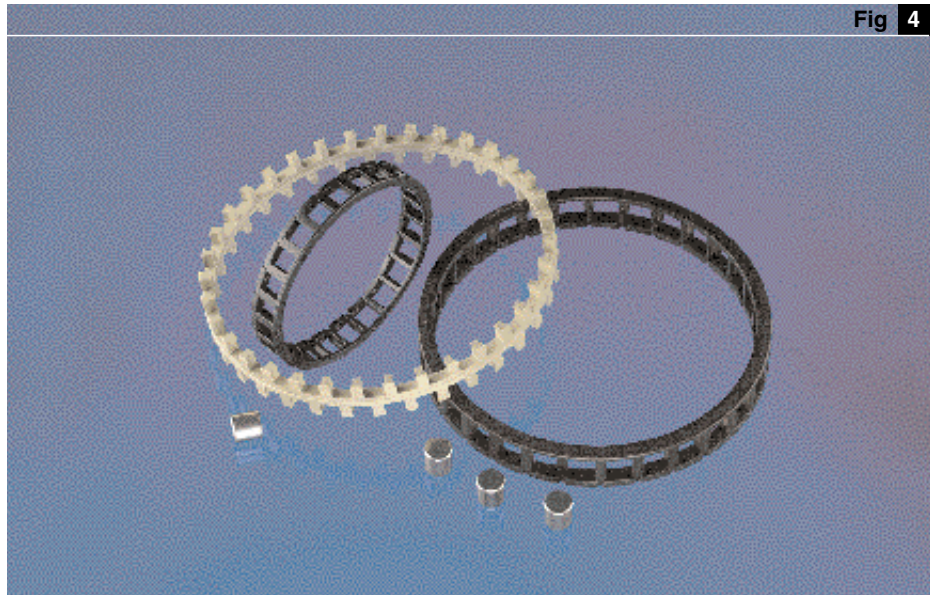

Cages for double row cylindrical roller bearings

Cages

SKF double row cylindrical roller bearings are fitted, depending on series and size with either

- two separate pronged cages with cover, made of polyamide 6,6 or
- one double pronged machined brass cage (→ fig 4)

The single row bearings of series N 10 K are fitted with the same polyamide cages as the corresponding size of series NN 30 K.

The bearings fitted with polyamide cages are identified by the designation suffix TN or TN9 and can be used without reservation at the temperatures normally occurring in machine tool applications. The cage properties are also not affected by the lubricants normally used for bearings, with the exception of some synthetic oils or greases with synthetic base oils.

Dimensions

The boundary dimensions of the bearings shown in the tables are in accordance with ISO 15-1981, Dimension Series 10, 30 and 49.

Tolerances

SKF high precision cylindrical roller bearings are produced to tolerance class SP specifications which were specially defined for machine tool applications. The double row bearings with tapered bore are also available to tolerance class UP specifications to special order.

The actual values of the tolerances for classes SP and UP are given in Table 3 to 5, pages 69 to 71.

Internal clearance

The bearings made to tolerance class SP are produced with C1 radial internal clearance as standard, although C1 does not appear in the bearing designation. The rings of one bearing may not be mixed with those of other bearings as otherwise the clearance may become inadmissibly large or small. The bearings are therefore supplied in individual packages, or if this is not the case, the components of a given bearing carry the same serial number.

Bearings to tolerance class SP, particularly those of series NNU 49, are also available with radial internal clearances greater than C1. When ordering it is necessary to state the required clearance class, viz.

- SPC2 Radial internal clearance greater than C1
- CN Normal radial internal clearance
- C3 Radial internal clearance greater than Normal

The clearance limits are given in **Table 1** and are in accordance with ISO 5753:1991. The SPC2 clearance range is narrower than specified by ISO for C2 and displaced to the smaller side. The values in the table apply to bearings before mounting and under zero measuring load.

Equivalent dynamic bearing load

For SKF high precision cylindrical roller bearings, which can only accommodate radial loads

$$P = F_r$$

Equivalent static bearing load

For SKF high precision cylindrical roller bearings, which can only accommodate radial loads

$$P_0 = F_r$$

Speed ratings

The ratings quoted in the bearings tables are guideline values which apply provided the bearings have a maximum preload in operation of 2 µm and the associated components are made with the recommended accuracy. Where heavier preloads occur or where the associated components are less accurate, the speed ratings must be reduced.

Radial internal clearance of cylindrical roller bearings

Table 1													
Bore diameter		Radial internal clearance Bearings with cylindrical bore								Bearings with tapered bore			
d	incl.	C1		SPC2		Normal		C3		C1		SPC2	
over		min	max	min	max	min	max	min	max	min	max	min	max
mm		µm											
24	30	5	15	10	25	20	45	35	60	15	25	25	35
30	40	5	15	12	25	25	50	45	70	15	25	25	40
40	50	5	18	15	30	30	60	50	80	17	30	30	45
50	65	5	20	15	35	40	70	60	90	20	35	35	50
65	80	10	25	20	40	40	75	65	100	25	40	40	60
80	100	10	30	25	45	50	85	75	110	35	55	45	70
100	120	10	30	25	50	50	90	85	125	40	60	50	80
120	140	10	35	30	60	60	105	100	145	45	70	60	90
140	160	10	35	35	65	70	120	115	165	50	75	65	100
160	180	10	40	35	75	75	125	120	170	55	85	75	110
180	200	15	45	40	80	90	145	140	195	60	90	80	120
200	225	15	50	45	90	105	165	160	220	60	95	90	135
225	250	15	50	50	100	110	175	170	235	65	100	100	150
250	280	20	55	55	110	125	195	190	260	75	110	110	165
280	315	20	60	60	120	130	205	200	275	80	120	120	180

Cylindrical roller bearings, double row
d 25 – 100 mm

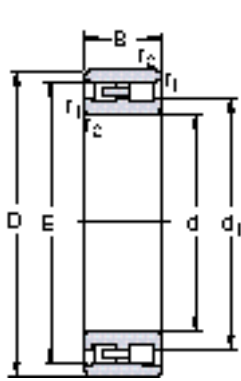

NN 30

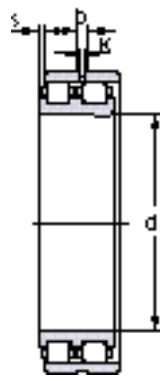

NN 30 KTN/W33



NNU 49 B/W33

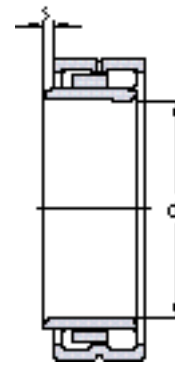

NNU 49 BK/W33

Principal dimensions			Basic load ratings		Fatigue load limit P_u	Speed ratings		Mass	Designation
d	D	B	dynamic	static		Lubrication grease	oil spot		
mm			C	C_0	N	r/min	kg	–	
25	47	16	26 000	30 000	3 100	19 000	22 000	0,12	NN 3005 K
30	55	19	30 800	37 500	3 900	16 000	18 000	0,19	NN 3006
	55	19	30 800	37 500	3 900	16 000	18 000	0,19	NN 3006 KTN
35	62	20	39 100	50 000	5 400	14 000	16 000	0,25	NN 3007
	62	20	39 100	50 000	5 400	14 000	16 000	0,25	NN 3007 K
40	68	21	42 900	56 000	6 480	12 000	14 000	0,30	NN 3008 TN
	68	21	42 900	56 000	6 480	12 000	14 000	0,30	NN 3008 KTN
45	75	23	50 100	65 500	7 650	11 000	13 000	0,38	NN 3009 TN
	75	23	50 100	65 500	7 650	11 000	13 000	0,38	NN 3009 KTN
50	80	23	52 800	73 500	8 500	10 000	12 000	0,42	NN 3010 TN/W33
	80	23	52 800	73 500	8 500	10 000	12 000	0,42	NN 3010 KTN/W33
55	90	26	69 300	96 500	11 600	9 500	11 000	0,62	NN 3011 TN/W33
	90	26	69 300	96 500	11 600	9 500	11 000	0,62	NN 3011 KTN/W33
60	95	26	73 700	106 000	12 700	9 000	10 000	0,66	NN 3012 TN/W33
	95	26	73 700	106 000	12 700	9 000	10 000	0,66	NN 3012 KTN/W33
65	100	26	76 500	116 000	13 700	8 500	9 500	0,71	NN 3013 TN/W33
	100	26	76 500	116 000	13 700	8 500	9 500	0,71	NN 3013 KTN/W33
70	110	30	96 800	150 000	17 300	7 500	8 500	1,00	NN 3014 TN/W33
	110	30	96 800	150 000	17 300	7 500	8 500	1,00	NN 3014 KTN/W33
75	115	30	96 800	150 000	17 600	7 000	8 000	1,10	NN 3015 TN/W33
	115	30	96 800	150 000	17 600	7 000	8 000	1,10	NN 3015 KTN/W33
80	125	34	119 000	186 000	22 000	6 700	7 500	1,45	NN 3016 TN/W33
	125	34	119 000	186 000	22 000	6 700	7 500	1,50	NN 3016 KTN/W33
85	130	34	125 000	204 000	23 200	6 300	7 000	1,60	NN 3017 TN9/W33
	130	34	125 000	204 000	23 200	6 300	7 000	1,55	NN 3017 KTN9/W33
90	140	37	138 000	216 000	26 000	6 000	6 700	2,00	NN 3018 TN9/W33
	140	37	138 000	216 000	26 000	6 000	6 700	1,95	NN 3018 KTN9/W33
95	145	37	142 000	232 000	27 500	5 600	6 300	2,10	NN 3019 TN9/W33
	145	37	142 000	232 000	27 500	5 000	6 300	2,05	NN 3019 KTN9/W33
100	140	40	128 000	255 000	29 000	5 600	6 300	1,90	NNU 4920 B/W33
	140	40	128 000	255 000	29 000	5 600	6 300	1,80	NNU 4920 BK/W33
	150	37	151 000	250 000	29 000	5 300	6 000	2,20	NN 3020 TN9/W33
	150	37	151 000	250 000	29 000	5 300	6 000	2,10	NN 3020 KTN9/W33

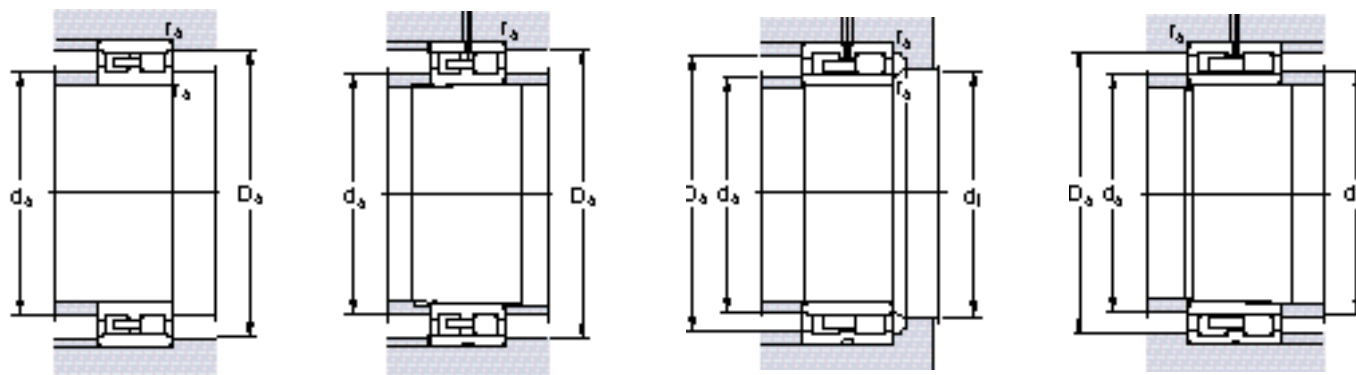

Dimensions

Abutment and fillet dimensions

d	d ₁ , D ₁ ≈	E, F	b	K	r _{1,2} min	s	d _a min	d _a max	d _b min	D _a max	D _a min	r _a max
mm							mm					
25	33,3	41,3	–	–	0,6	1,4	29	–	–	43	42	0,6
30	39,7	48,5	–	–	1	1,8	35	–	–	50	49	1
	39,7	48,5	–	–	1	1,8	35	–	–	50	49	1
35	45,4	55	–	–	1	1,8	40	–	–	57	56	1
	45,4	55	–	–	1	1,8	40	–	–	57	56	1
40	50,6	61	–	–	1	1,3	45	–	–	63	62	1
	50,6	61	–	–	1	1,3	45	–	–	63	62	1
45	56,3	67,5	–	–	1	2	50	–	–	70	69	1
	56,3	67,5	–	–	1	2	50	–	–	70	69	1
50	61,3	72,5	3,7	2	1	2	55	–	–	75	74	1
	61,3	72,5	3,7	2	1	2	55	–	–	75	74	1
55	68,2	81	3,7	2	1,1	2	61,5	–	–	83,5	82	1
	68,2	81	3,7	2	1,1	2	61,5	–	–	83,5	82	1
60	73,3	86,1	3,7	2	1,1	2	66,5	–	–	88,5	87	1
	73,3	86,1	3,7	2	1,1	2	66,5	–	–	88,5	87	1
65	78,2	91	3,7	2	1,1	2	71,5	–	–	93,5	92	1
	78,2	91	3,7	2	1,1	2	71,5	–	–	93,5	92	1
70	85,6	100	5,5	3	1,1	2,5	76,5	–	–	103,5	101	1
	85,6	100	5,5	3	1,1	2,5	76,5	–	–	103,5	101	1
75	90,6	105	5,5	3	1,1	2,5	81,5	–	–	108,5	106	1
	90,6	105	5,5	3	1,1	2,5	81,5	–	–	108,5	106	1
80	97	113	5,5	3	1,1	3	86,5	–	–	118,5	114	1
	97	113	5,5	3	1,1	3	86,5	–	–	118,5	114	1
85	102	118	5,5	3	1,1	2,5	91,5	–	–	123,5	119	1
	102	118	5,5	3	1,1	2,5	91,5	–	–	123,5	119	1
90	109	127	5,5	3	1,5	2,8	98	–	–	132	129	1,5
	109	127	5,5	3	1,5	2,8	98	–	–	132	129	1,5
95	114	132	5,5	3	1,5	2,8	103	–	–	137	134	1,5
	114	132	5,5	3	1,5	2,8	103	–	–	137	134	1,5
100	126	113	5,5	3	1,1	1,7	106,5	111	116	133,5	–	1
	126	113	5,5	3	1,1	1,7	106,5	111	116	133,5	–	1
	119	137	5,5	3	1,5	2,8	108	–	–	142	139	1,5
	119	137	5,5	3	1,5	2,8	108	–	–	142	139	1,5

Cylindrical roller bearings, double row
d 105 – 220 mm

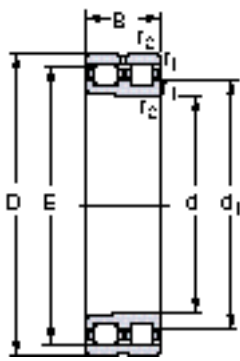

NN 30 KTN9/W33



NN 30 K/W33



NNU 49 B/W33

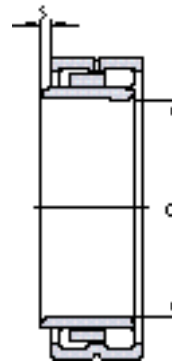

NNU 49 BK/W33

Principal dimensions			Basic load ratings		Fatigue load limit P_u	Speed ratings		Mass	Designation
d	D	B	dynamic C	static C_0		Lubrication grease	oil spot		
mm			N		N	r/min	kg	–	
105	145	40	130 000	260 000	29 000	5 300	6 000	2,00	NNU 4921 B/W33
	145	40	130 000	260 000	29 000	5 300	6 000	1,90	NNU 4921 BK/W33
	160	41	190 000	305 000	36 000	5 000	5 600	2,70	NN 3021 KTN9/W33
110	150	40	132 000	270 000	30 000	5 300	6 000	2,05	NNU 4922 B/W33
	150	40	132 000	270 000	30 000	5 300	6 000	1,95	NNU 4922 BK/W33
	170	45	220 000	360 000	41 500	4 800	5 300	3,40	NN 3022 KTN9/W33
120	165	45	176 000	340 000	37 500	4 800	5 300	2,80	NNU 4924 B/W33
	165	45	176 000	340 000	37 500	4 800	5 300	2,65	NNU 4924 BK/W33
	180	46	229 000	390 000	44 000	4 500	5 000	3,70	NN 3024 KTN9/W33
130	180	50	187 000	390 000	41 500	4 300	4 800	3,85	NNU 4926 B/W33
	180	50	187 000	390 000	41 500	4 300	4 800	3,65	NNU 4926 BK/W33
	200	52	286 000	475 000	53 000	4 000	4 500	5,55	NN 3026 KTN9/W33
140	190	50	190 000	400 000	41 500	4 000	4 500	4,10	NNU 4928 B/W33
	190	50	190 000	400 000	41 500	4 000	4 500	3,90	NNU 4928 BK/W33
	210	53	297 000	520 000	56 000	3 800	4 300	6,00	NN 3028 K/W33
150	210	60	330 000	655 000	71 000	3 800	4 300	6,25	NNU 4930 B/W33
	210	60	330 000	655 000	71 000	3 800	4 300	6,15	NNU 4930 BK/W33
	225	56	330 000	570 000	62 000	3 600	4 000	7,30	NN 3030 K/W33
160	220	60	330 000	680 000	72 000	3 600	4 000	6,60	NNU 4932 B/W33
	220	60	330 000	680 000	72 000	3 600	4 000	6,30	NNU 4932 BK/W33
	240	60	369 000	655 000	69 500	3 400	3 800	8,80	NN 3032 K/W33
170	230	60	336 000	695 000	73 500	3 400	3 800	6,95	NNU 4934 B/W33
	230	60	336 000	695 000	73 500	3 400	3 800	6,65	NNU 4934 BK/W33
	260	67	457 000	815 000	85 000	3 000	3 400	12,0	NN 3034 K/W33
180	250	69	402 000	850 000	88 000	3 000	3 400	10,5	NNU 4936 B/W33
	250	69	402 000	850 000	88 000	3 000	3 400	10,0	NNU 4936 BK/W33
	280	74	561 000	1 000 000	102 000	2 800	3 200	16,0	NN 3036 K/W33
190	260	69	402 000	880 000	90 000	2 800	3 200	11,0	NNU 4938 B/W33
	260	69	402 000	880 000	90 000	2 800	3 200	10,5	NNU 4938 BK/W33
	290	75	594 000	1 080 000	108 000	2 600	3 000	17,0	NN 3038 K/W33
200	280	80	484 000	1 040 000	106 000	2 600	3 000	15,0	NNU 4940 B/W33
	280	80	484 000	1 040 000	106 000	2 600	3 000	14,5	NNU 4940 BK/W33
	310	82	644 000	1 140 000	118 000	2 400	2 800	21,0	NN 3040 K/W33
220	300	80	512 000	1 140 000	114 000	2 400	2 800	16,5	NNU 4944 B/W33
	300	80	512 000	1 140 000	114 000	2 400	2 800	16,0	NNU 4944 BK/W33
	340	90	809 000	1 460 000	143 000	2 200	2 600	27,5	NN 3044 K/W33

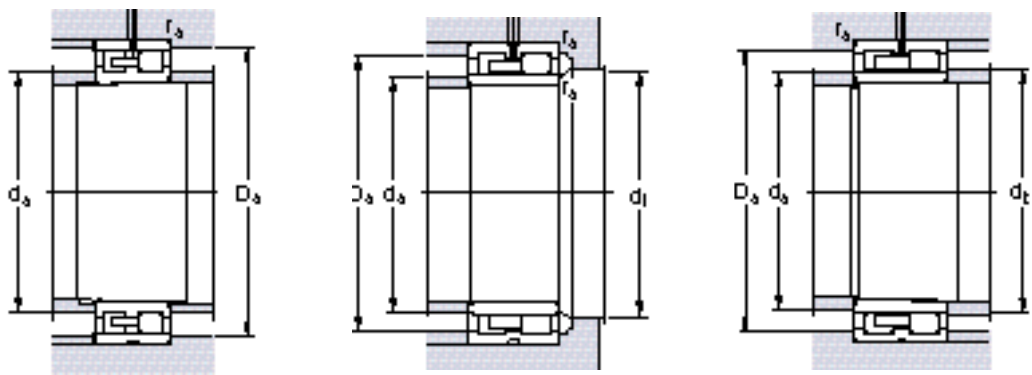

Dimensions

Abutment and fillet dimensions

d	d ₁ , D ₁ ≈	E, F	b	K	r _{1,2} min	s	d _a min	d _a max	d _b min	D _a max	D _a min	r _a max
mm							mm					
105	131	118	5,5	3	1,1	1,7	111,5	116	121	138,5	–	1
	131	118	5,5	3	1,1	1,7	111,5	116	121	138,5	–	1
	125	146	5,5	3	2	1,8	115	–	–	150	148	2
110	136	123	5,5	3	1,1	1,7	116,5	121	126	143,5	–	1
	136	123	5,5	3	1,1	1,7	116,5	121	126	143,5	–	1
	132	155	5,5	3	2	3,8	120	–	–	160	157	2
120	151	134,5	5,5	3	1,1	1,7	126,5	133	137	158,5	–	1
	151	134,5	5,5	3	1,1	1,7	126,5	133	137	158,5	–	1
	142	165	5,5	3	2	3,8	130	–	–	170	167	2
130	162	146	5,5	3	1,5	2,2	138	144	149	172	–	1,5
	162	146	5,5	3	1,5	2,2	138	144	149	172	–	1,5
	156	182	8,3	4,5	1,1	3,8	140	–	–	190	183	2
140	172	156	5,5	3	1,5	2,2	148	154	159	182	–	1,5
	172	156	5,5	3	1,5	2,2	148	154	159	182	–	1,5
	166	192	8,3	4,5	2	3,8	150	–	–	200	194	2
150	191	168,5	5,5	3	2	2	160	166	172	200	–	2
	191	168,5	5,5	3	2	2	160	166	172	200	–	2
	178	206	8,3	4,5	2,1	4	161	–	–	214	208	2
160	201	178,5	5,5	3	2	2	170	176	182	210	–	2
	201	178,5	5,5	3	2	2	170	176	182	210	–	2
	190	219	8,3	4,5	2,1	5	171	–	–	229	221	2
170	211	188,5	5,5	3	2	2	180	186	192	220	–	2
	211	188,5	5,5	3	2	2	180	186	192	220	–	2
	204	236	8,3	4,5	2,1	5	181	–	–	249	238	2
180	226	202	8,3	4,5	2	1,1	190	199	205	240	–	2
	226	202	8,3	4,5	2	1,1	190	199	205	240	–	2
	218	255	11,1	6	2,1	5	191	–	–	269	257	2
190	236	212	8,3	4,5	2	1,1	200	209	215	250	–	2
	236	212	8,3	4,5	2	1,1	200	209	215	250	–	2
	228	265	11,1	6	2,1	5	201	–	–	279	267	2
200	253	225	11,1	6	2,1	3,7	211	222	228	269	–	2
	253	225	11,1	6	2,1	3,7	211	222	228	269	–	2
	242	282	11,1	6	2,1	6,5	211	–	–	299	285	2
220	273	245	11,1	6	2,1	3,7	231	242	249	289	–	2
	273	245	11,1	6	2,1	3,7	231	242	249	289	–	2
	265	310	13,9	7,5	3	7,4	233	–	–	327	313	2,5

Cylindrical roller bearings, double row
d 220 – 300 mm

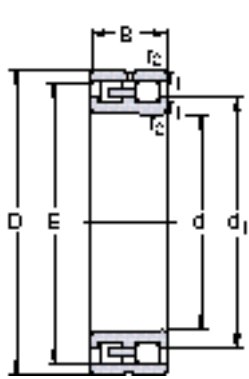

NN 30 K/W33



NN 30 K/W33

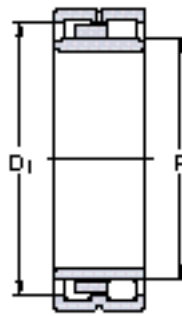

NNU 49 B/W33

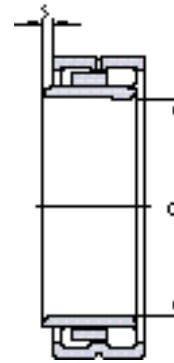

NNU 49 BK/W33

Principal dimensions			Basic load ratings		Fatigue load limit P_u	Speed ratings		Mass	Designation
d	D	B	dynamic C	static C_0		Lubrication grease	oil spot		
mm			N		N	r/min	kg	–	
240	320	80	528 000	1 220 000	118 000	2 200	2 600	17,5	NNU 4948 B/W33
	320	80	528 000	1 220 000	118 000	2 200	2 600	16,5	NNU 4948 BK/W33
	360	92	842 000	1 560 000	153 000	2 000	2 400	30,5	NN 3048 K/W33
260	360	100	748 000	1 700 000	163 000	2 000	2 400	30,5	NNU 4952 B/W33
	360	100	748 000	1 700 000	163 000	2 000	2 400	29,5	NNU 4952 BK/W33
280	380	100	765 000	1 800 000	170 000	1 900	2 200	32,5	NNU 4956 B/W33
	380	100	765 000	1 800 000	170 000	1 900	2 200	31,5	NNU 4956 BK/W33
300	420	118	1 020 000	2 360 000	224 000	1 800	2 000	50,0	NNU 4960 B/W33
	420	118	1 020 000	2 360 000	224 000	1 800	2 000	48,5	NNU 4960 BK/W33

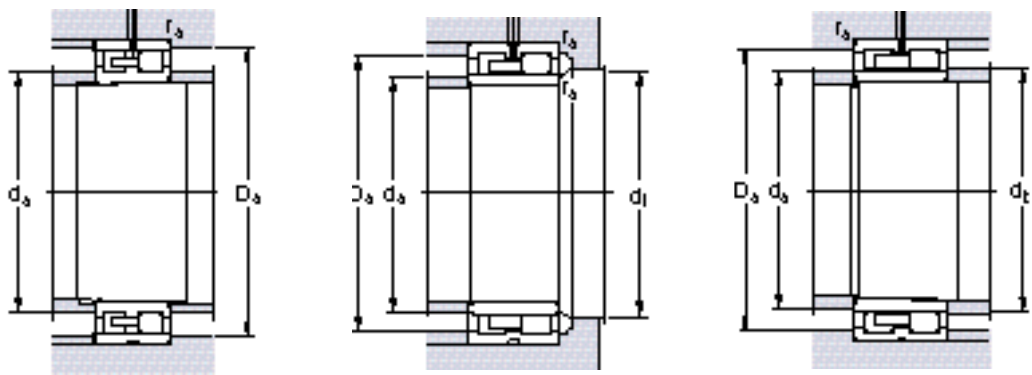

Dimensions

Abutment and fillet dimensions

d	d ₁ , D ₁ ≈	E, F	b	K	r _{1,2} min	s	d _a min	d _a max	d _b min	D _a max	D _a min	r _a max
mm							mm					
240	293	265	11,1	6	2,1	3,7	251	262	269	309	–	2
	293	265	11,1	6	2,1	3,7	251	262	269	309	–	2
	285	330	13,9	7,5	3	7,4	253	–	–	347	333	2,5
260	326	292	13,9	7,5	2,1	4,5	271	288	296	349	–	2
	326	292	13,9	7,5	2,1	4,5	271	288	296	349	–	2
280	346	312	13,9	7,5	2,1	4,5	291	308	316	369	–	2
	346	312	13,9	7,5	2,1	4,5	291	308	316	369	–	2
300	379	339	16,7	9	3	5,5	313	335	343	407	–	2,5
	379	339	16,7	9	3	5,5	313	335	343	407	–	2,5

Cylindrical roller bearings, single row
d 50 – 110 mm

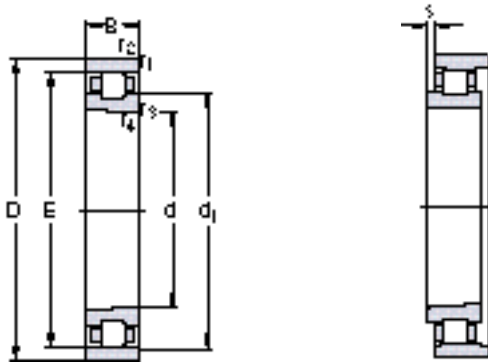

Principal dimensions			Basic load ratings		Fatigue load limit P_u	Speed ratings		Mass	Designation
d	D	B	dynamic C	static C_0		Lubrifications			
			N		N	grease	oil spot	kg	–
mm			N		N	r/min		kg	–
50	80	16	30 800	36 500	4 250	12 000	14 000	0,26	N 1010 KTN
65	100	18	44 600	58 500	6 800	9 500	11 000	0,44	N 1013 KTN
70	110	20	57 200	75 000	8 650	9 000	10 000	0,62	N 1014 KTN
80	125	22	69 300	93 000	11 000	8 000	9 000	0,89	N 1016 KTN9
85	130	22	73 700	102 000	11 600	7 500	8 500	0,93	N 1017 KTN9
95	145	24	84 200	116 000	14 000	6 700	7 500	1,25	N 1019 KTN9
100	150	24	88 000	125 000	14 600	6 700	7 500	1,30	N 1020 KTN9
110	170	28	128 000	180 000	20 800	5 600	6 300	2,05	N 1022 KTN9

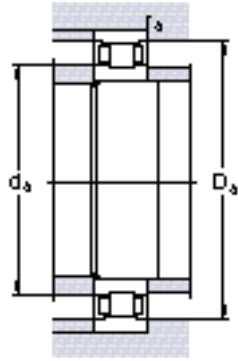
Dimensions
Abutment and fillet dimensions

d	d_1 ≈	E	$r_{1,2}$ min	$r_{3,4}$ min	s	d_a min	d_a max	D_a min	D_a max	r_a max
mm						mm				
50	61,3	72,5	1	0,5	3	55	70	74	75	1
65	78,2	91	1,1	0,6	3	71,5	89	92	93,5	1
70	85,6	100	1,1	0,6	3,5	76,5	98	101	103,5	1
80	97	113	1,1	0,6	3,5	86,5	110	114	118,5	1
85	102	118	1,1	0,6	3,5	91,5	115	119	123,5	1
95	114	132	1,5	1	4	103	129	134	137	1,5
100	119	137	1,5	1	4	108	134	139	142	1,5
110	132	155	2	1	4	119	152	157	161	2

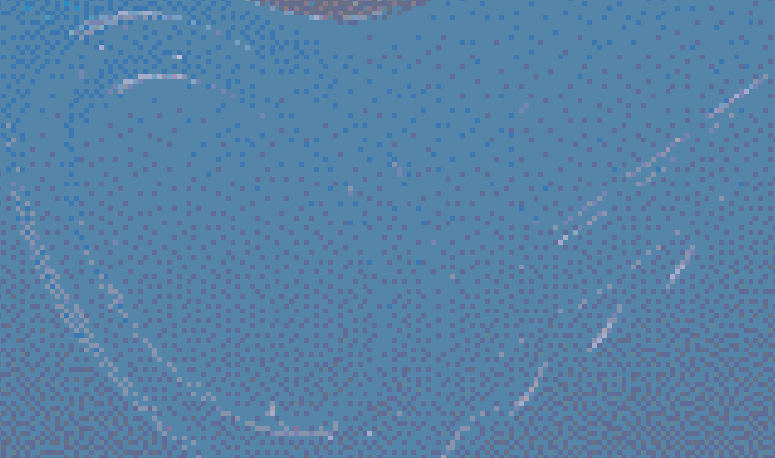
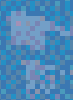
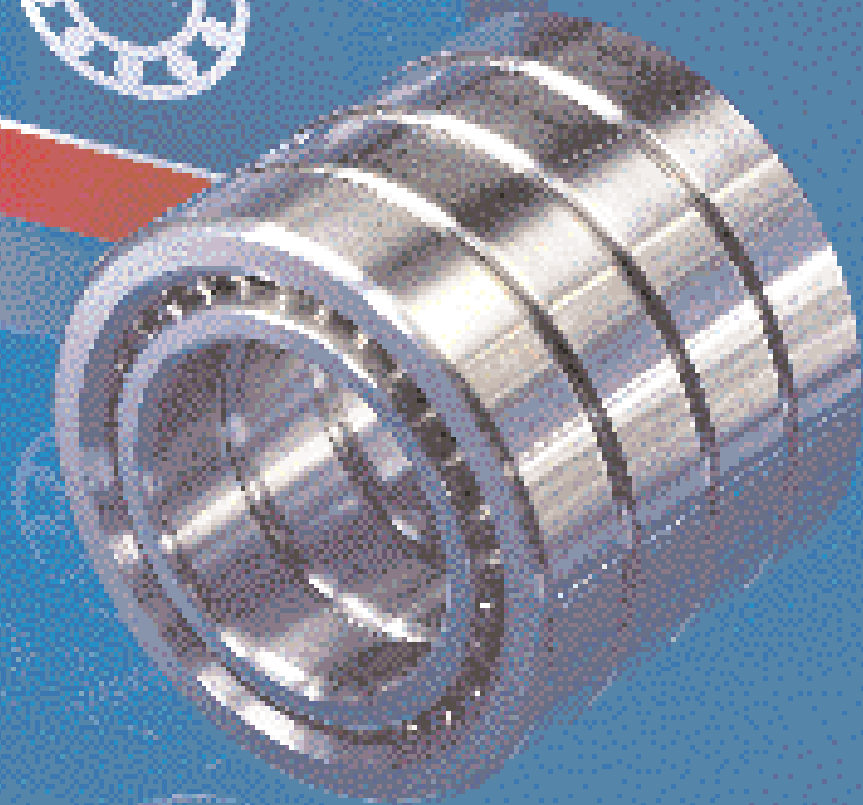

Single direction angular contact thrust ball bearings

The single direction angular contact thrust ball bearings (screw support bearings) were specially developed for the support of ball and roller screws in machine tool applications, but can be used successfully in other applications. The bearings are characterised by high axial stiffness, high running accuracy and low friction torque.

SKF single direction angular contact thrust ball bearings are non-separable. The particularly close conformity of the raceways to the balls and the contact angle of 60° contribute to the necessary high axial stiffness and high axial load carrying capacity.

Single direction angular contact thrust ball bearings can only accept axial loads acting in one direction and must therefore be adjusted against a second bearing which provides location in the opposite direction. To meet all the demands for different bearing arrangements, these bearings can be supplied singly for universal mounting or in matched sets. Bearing sets are used when the load carrying capacity of a single bearing is inadequate and/or when the bearing arrangement is required to take up axial loads acting in both directions.

Matched bearing sets

SKF single direction angular contact ball bearings can be supplied in matched sets of two, three or four bearings. The possible combinations are shown in **fig 1**.

The sets of bearings are matched during production so that when mounted immediately adjacent to each other, the predetermined value of the preload and/or an even distribution of the load will be obtained. The bore and outside diameters of the bearings of a set differ at the most by half the permissible tolerance range.

To ensure that the bearings of a set are mounted in the right order, the outside cylindrical surfaces are marked with a "V". The matched bearing sets are supplied as packaged units, each bearing of the set being individually packed within the unit package.

Possible combinations of matched bearing sets

Fig 1

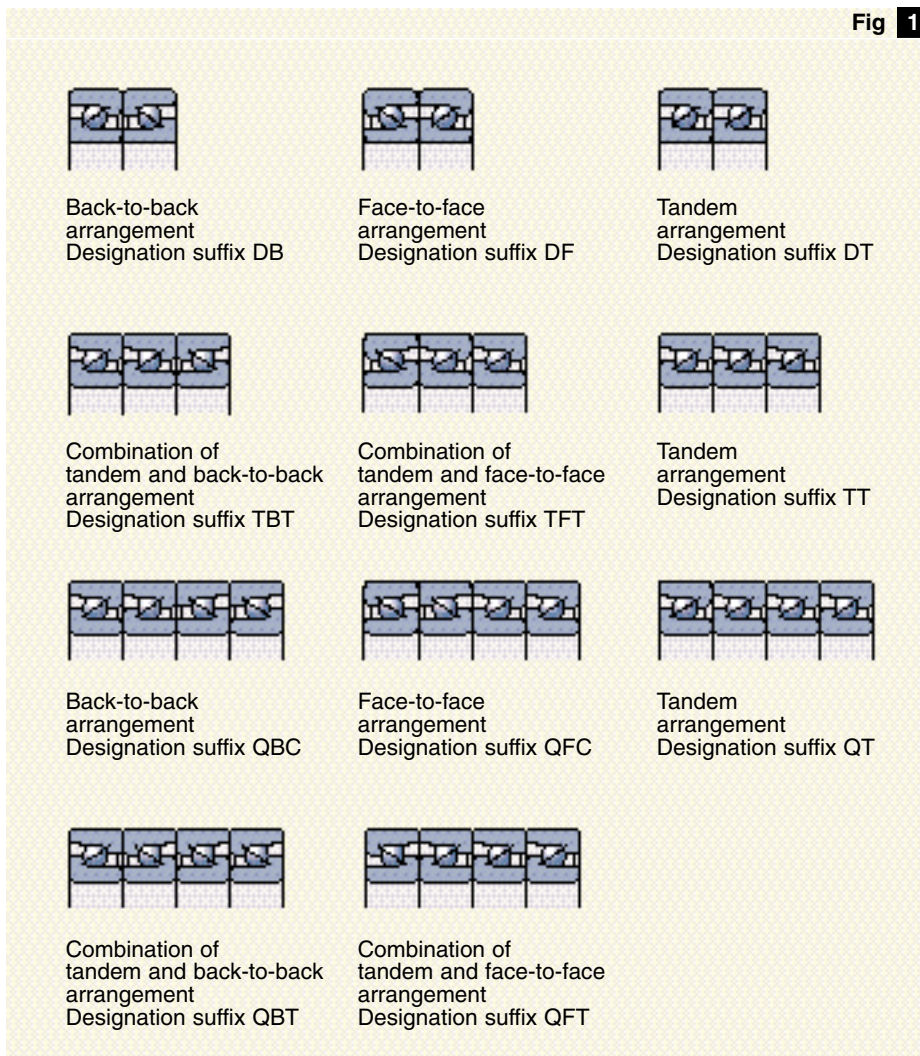

Bearings for universal mounting

A special design of the single direction angular contact thrust ball bearings is available for universal mounting in sets. These bearings are produced so that they can be mounted immediately adjacent to each other in random order. When mounted in a back-to-back or face-to-face arrangement, the bearings will have a suitable preload.

Bearings for universal pairing are identified by the suffix G followed by A or B to indicate the preload class, e.g. BSD 2047 C/GA. When ordering, it is necessary to state the number of individual bearings required and not the number of sets.

Sets of two bearings for universal pairing which have matched bore and outside diameters are also available. These bearings are identified by the designation suffix DGA or DGB, depending on preload class, e.g. BSD 2047 C/DGB. Here it is necessary to state the number of sets required when ordering, not the number of individual bearings.

Cartridge units

In order to simplify still further the arrangement and mounting of screw support bearings, cartridge units consisting of SKF single direction angular contact ball bearings filled with grease and mounted in a flanged housing are also available (→ fig 2). There is a choice of units with two bearings, or two bearing pairs in tandem, arranged back-to-back or face-to-face. Further details will be supplied on request.



Fig 2

Cages

SKF single direction angular contact thrust ball bearings are fitted with a ball-centred cage of glass fibre reinforced polyamide 6,6.

Dimensions

The boundary dimensions of SKF single row angular contact thrust ball bearings of series BSA 2 and BSA 3 follow the Dimension Plan for radial bearings in ISO 15-1981. The dimensions of bearings of series BSD and BDAB are not standardised.

Tolerances

SKF single direction angular contact thrust ball bearings are made to the tolerances shown in Table 6 on page 72. The dimensional accuracy corresponds to ISO 492:1994 class 4, whilst the running accuracy is according to ANSI/ABMA Std. 20-1987, although these standards apply to radial bearings. The values given in the table apply to single bearings.

The axial runout (lateral eccentricity) of a single direction angular contact thrust ball bearing is an important parameter. For matched sets which are correctly mounted on accurately machined seatings, the axial runout will generally not exceed 2,5 µm.

Preload

All bearing sets of two bearings arranged back-to-back or face-to-face are available with preload to class A and class B (→ Table 1). The values given in the table refer to unmounted bearing pairs, i.e. the bearing rings are free to expand. This means that after mounting the preload will increase, the increase being greater, the tighter the fit applied.

Matched sets of 3 and 4 bearings arranged back-to-back or face-to-face have a higher preload. The appropriate values can be obtained by multiplying the values given in the table by

1,35 for TBT and TFT sets
1,60 for QBT and QFT sets
2,00 for QBC and QFC sets

Axial stiffness

Single direction angular contact thrust ball bearings are designed for high stiffness. The actual values are given in Table 1 and apply to bearing sets of two bearings arranged back-to-back or face-to-face.

Matched sets of 3 and 4 bearings arranged back-to-back or face-to-face have a higher axial stiffness. The appropriate values can be obtained by multiplying the values given in the table by

1,45 for TBT and TFT sets
1,80 for QBT and QFT sets
2,00 for QBC and QFC sets

Friction torque

SKF single direction angular contact thrust ball bearings have low friction. The actual values for the torque are given in Table 1 and are valid for unmounted bearing sets of two bearings.

Matched sets of 3 and 4 bearings arranged back-to-back or face-to-face have a higher friction torque. The appropriate values can be obtained by multiplying the values given in the table by

1,35 for TBT and TFT sets
1,55 for QBT and QFT sets
2,00 for QBC and QFC sets

Speed ratings

The speed ratings given in the bearing tables are guideline values and apply to single bearings. Speed ratings for matched sets of 2, 3 or 4 bearings are obtained by multiplying the values given in the table by

0,8 for sets of 2 bearings
0,65 for sets of 3 bearings
0,5 for sets of 4 bearings

Cartridge unit with four single direction angular contact thrust ball bearings

Preload, axial stiffness and friction torque

Equivalent dynamic bearing load

The equivalent dynamic bearing load for single bearings and bearing sets can be calculated separately for the two directions of axial load from

$$P = YF_a + XF_r \quad \text{where } F_a/F_r \leq 2,17$$

$$P = F_a + 0,92 F_r \quad \text{where } F_a/F_r > 2,17$$

When calculating F_a , the preload force acting on the bearing set must be taken into account. The calculation factors X and Y can be obtained from **Table 2**.

Equivalent static bearing load

For bearing sets with bearings arranged back-to-back or face-to-face, the equivalent static bearing load can be calculated separately for each direction of axial load from

$$P_0 = F_a + 4 F_r$$

The equation is also valid for single bearings and sets of bearings arranged in tandem provided the ratio F_r/F_a does not exceed 0,25 and gives satisfactory but less accurate values when F_r/F_a is greater than 0,25 but does not exceed 0,4.

Load carrying capacity of bearing sets

The values of the basic dynamic and static load ratings given in the bearing tables relate to single bearings. For sets of bearings it must be remembered that each bearing can only support axial loads acting in one direction. It is therefore necessary to calculate using only the number of bearings supporting the load in a given direction, i.e. for a pair of bearings arranged back-to-back, only one bearing will carry the load in a given direction. Appropriate guidance for the calculation of the basic dynamic and static load ratings of matched bearing sets is given in the **Table 2**. The arrows indicate the direction of the load acting on the outer rings.

Calculation factors for bearing sets

Table 1

Designation	Preload class		Axial stiffness class		Friction torque class	
	A	B	A	B	A	B
–	N		N/μm		Nm	
BSA 201 C	650	1 300	345	440	0,016	0,029
BSA 202 C	775	1 550	408	522	0,023	0,040
BSA 204 C	1 480	2 960	587	750	0,056	0,100
BSA 205 C	1 580	3 160	632	807	0,077	0,132
BSA 206 C	2 250	4 500	809	1 036	0,130	0,225
BSA 207 C	2 950	5 900	960	1 228	0,200	0,345
BSA 305 C	2 400	4 800	785	1 000	0,120	0,215
BSA 306 C	3 300	6 600	900	1 145	0,194	0,345
BSA 307 C	4 500	9 000	1 055	1 355	0,290	0,523
BSD 1547 C	1 480	2 960	587	750	0,056	0,100
BSD 2047 C	1 480	2 960	587	750	0,056	0,100
BSD 2562 C	2 400	4 800	785	1 000	0,120	0,215
BSD 3062 C	2 250	4 500	809	1 036	0,130	0,224
BSD 3572 C	2 950	5 900	960	1 228	0,200	0,345
BSD 55100 C	6 500	13 000	1 390	1 770	0,550	0,970
BDAB 634200 C	1 480	2 960	587	750	0,056	0,100
BDAB 634201 C	2 400	4 800	785	1 000	0,120	0,215
BDAB 634203 C	2 900	5 800	1 065	1 355	0,255	0,415

Table 2

No. of bearings and arrangement	Load carrying capacity of bearing set	dynamic	static	Calculation factors	
				X	Y
2 DB		C	C ₀	1,9	0,55
		C	C ₀	1,9	0,55
		1,63 C	2 C ₀	–	–
3 TBT		C	C ₀	1,43	0,76
		1,63 C	2 C ₀	2,32	0,35
		C	C ₀	1,43	0,76
4 TT		1,63 C	2 C ₀	2,32	0,35
		2,16 C	3 C ₀	–	–
		2,16 C	3 C ₀	–	–
4 QBT		C	C ₀	1,17	0,88
		2,16 C	3 C ₀	2,52	0,26
		C	C ₀	1,17	0,88
QFT		C	C ₀	1,17	0,88
		2,16 C	3 C ₀	2,52	0,26
		2,16 C	3 C ₀	2,52	0,26
QBC		1,63 C	2 C ₀	1,9	0,55
		1,63 C	2 C ₀	1,9	0,55
		1,63 C	2 C ₀	1,9	0,55
QFC		1,63 C	2 C ₀	1,9	0,55
		1,63 C	2 C ₀	1,9	0,55
QT		2,64 C	4 C ₀	–	–

Angular contact thrust ball bearing, single direction

d 12 – 55 mm

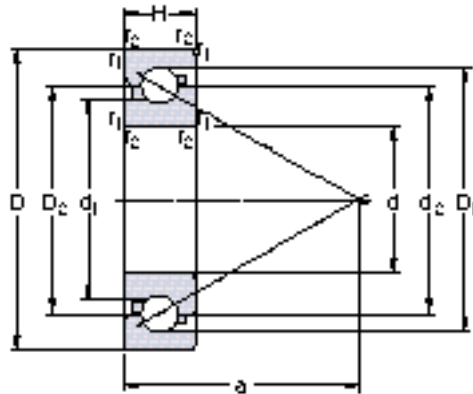

Principal dimensions			Basic load ratings		Fatigue load limit P_u	Maximum axial load	Speed ratings		Mass	Designation						
d	D	H	dynamic C	static C_0			Lubrication grease	oil spot								
mm			N		N	N	r/min		kg	–						
12	32	10	11 200	15 600	710	7 250	12 000	16 000	0,024	BSA 201 C						
15	35	11	12 100	18 600	850	8 500	11 000	15 000	0,054	BSA 202 C						
	47	15	21 200	35 500							1 600	19 500	8 200	11 000	0,15	BSD 1547 C
20	47	14	21 200	35 500	1 600	19 500	8 200	11 000	0,13	BSA 204 C						
	47	15	21 200	35 500							1 600	19 500	8 200	11 000	0,13	BSD 2047 C
	47	15,875	21 200	35 500							1 600	19 500	7 500	10 000	0,14	BDAB 634200 C
23,838	61,999	15,875	32 500	58 500	2 700	36 000	6 900	9 300	0,26	BDAB 634201 C						
25	52	15	21 600	38 000	1 730	20 800	7 500	10 000	0,15	BSA 205 C						
	62	15	32 500	58 500							2 700	36 000	7 200	9 600	0,25	BSD 2562 C
	62	17	32 500	58 500							2 700	36 000	6 700	9 000	0,27	BSA 305 C
30	62	16	28 100	54 000	2 500	31 500	6 900	9 300	0,24	BSA 206 C						
	62	15	28 100	54 000							2 500	31 500	7 200	9 600	0,22	BSD 3062 C
	72	19	44 200	80 000							3 600	52 800	5 900	7 900	0,41	BSA 306 C
35	72	15	35 100	71 000	3 250	42 750	6 600	8 900	0,30	BSD 3572 C						
	72	17	35 100	71 000							3 250	42 750	6 300	8 400	0,34	BSA 207 C
	80	21	58 500	108 000							4 900	69 000	5 700	7 100	0,56	BSA 307 C
40	72	15	35 100	71 000	3 250	42 750	6 600	8 900	0,30	BSD 4072 C						
	90	20	61 800	122 000							4 700	78 200	5 100	6 900	0,64	BSD 4090 C
44,475	76,2	15,875	31 200	69 500	3 250	40 200	6 300	8 400	0,31	BDAB 634203 C						
45	100	20	79 300	160 000	7 350	107 400	4 800	6 500	0,80	BSD 45100 C						
50	100	20	79 300	160 000	7 350	107 400	4 800	6 500	0,80	BSD 50100 C						
55	100	20	79 300	160 000	7 350	107 400	4 800	6 500	0,70	BSD 55100 C						

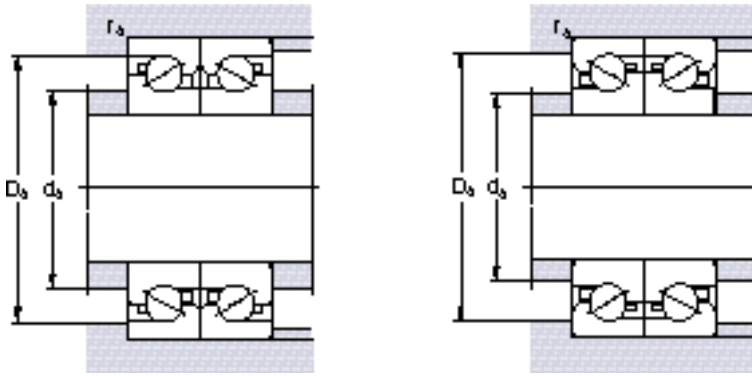

Dimensions

Abutment and fillet dimensions

d	d ₁ ≈	d ₂ ≈	D ₁ ≈	D ₂ ≈	r _{1,2} min	a	d _a min	D _a max	r _a max
mm	mm								
12	18	22,2	27,1	22,7	0,6	24	16	28	0,6
15	21 29,2	25,2 34,7	30,1 41,1	24,8 34,2	0,6 1	27 37	19 22,5	31 42	0,6 1
20	29,2 29,2 29,2	34,7 34,7 34,7	41,1 41,1 41,1	34,2 34,2 34,2	1 1 1	36 37 38	26,5 26,5 26,5	42 42 42	1 1 1
23,838	39,4	46,2	54,2	45,6	1,1	47	32,5	55	1
25	33,2 39,4 39,4	38,7 46,2 46,2	45,1 54,2 54,2	38,2 45,6 45,6	1 1,1 1,1	40 47 48	31 34 34	47 55 55	1 1 1
30	41 41 43,3	47,2 47,2 51,7	54,4 54,4 61,2	46,6 46,6 51,1	1 1 1,1	48 48 54	37 37 40	56,5 56,5 64,5	1 1 1
35	48,4 48,4 48,9	55,2 55,2 58,7	63,1 63,1 69,8	54,6 54,6 58,1	1,1 1,1 1,5	55 56 61	43,5 43,5 46,5	65 65 71,5	1 1 1,5
40	48,4 56,9	55,2 66,7	63,1 77,8	54,6 66,1	1,1 1,5	55 69	47,4 51,5	65,3 81,4	1 1,5
44,475	54	60,2	67,4	59,6	1,1	59	52	69,5	1
45	65,5	76,7	89,4	76,1	1,5	76	58,1	90,5	1,5
50	65,5	76,7	89,4	76,1	1,5	76	58,1	90,5	1,5
55	65,5	76,7	89,4	76,1	1,5	76	65,5	90,5	1,5



Double direction angular contact thrust ball bearings

Double direction angular contact thrust ball bearings were developed many years ago by SKF. They are used to axially locate a spindle in both directions and are intended for use together with cylindrical roller bearings of series NN 30 K and N 10 K.

Double direction angular contact thrust ball bearings have the same bore and outside diameters as the cylindrical roller bearings of series NN 30 K and N 10 K. The outside diameter of the housing washer is, however, made to tolerances such that sufficient radial clearance will be obtained to the housing bore seating, which is common to the

thrust bearing and the cylindrical roller bearing. The machining of the housing bore is also simplified.

Two designs of SKF double direction angular contact thrust ball bearings are available: the standard design of series 2344(00) and the high-speed design of series BTM .. A and BTM .. B.

Standard bearings, series 2344(00)

The bearings of series 2344(00) are separable and have a one-piece housing washer, two ball and cage thrust assemblies and two shaft washers, separated by a spacer sleeve (→ fig 1) so dimensioned that after mounting the bearings will be preloaded. The contact angle of 60°, the preload and the large number of balls in each row give the bearings high axial stiffness and enable them to operate at relatively high speeds.

To ensure efficient lubrication, all bearings have an annular groove and three lubrication holes in the housing washer.

High-speed bearings, BTM design

The SKF high-speed bearings of the BTM design (→ fig 2) are a new development and replace the bearings of the BTA design which are no longer

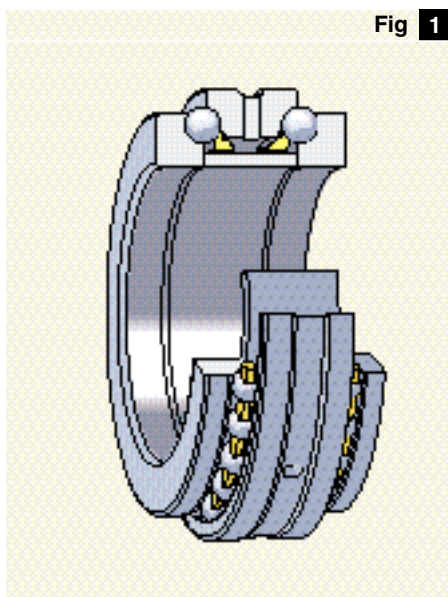

Fig 1

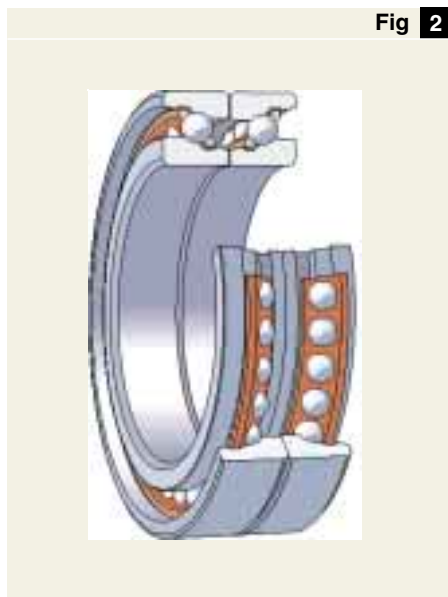

Fig 2

Fig 1
Double direction angular contact thrust ball bearing, series 2344(00)

Fig 2
Double direction angular contact thrust ball bearing, series BTM .. A

Double direction angular contact thrust ball bearings

produced. Their design is essentially that of two matched single row angular contact ball bearings arranged back-to-back. The contact angle is 40° for series BTM .. B and 30° for series BTM .. A. The bore and outside diameters of both series are the same as those of series 2344(00) bearings but they are 25 % narrower. They are of simple design so that mounting is easy.

Because the contact angle of the BTM-design bearings is less steep than that of the 2344(00) series bearings they are not as axially stiff and cannot carry such heavy axial loads but they are able to operate at 12 and almost 30 % higher speeds, respectively. As both the standard and high-speed bearings are intended to carry axial loads exclusively, the load ratings quoted in the bearing table are for axial loads, although the high-speed bearings with their contact angles of 40° and 30° are, by ISO definition, radial bearings.

The high permissible operating speeds make the BTM-design bearings eminently suitable for CNC lathes and milling machines where the requisite high radial stiffness of the high-speed spindles calls for the use of cylindrical roller bearings and where the speeds exceed the capability of the 2344(00) series bearings.

The SKF range of high-speed bearings covers five sizes of each series having bore diameters of 80 to 130 mm, inclusive, to cover the most common spindle diameters.

Dimensions

The dimensions of these double direction angular contact thrust ball bearings are not standardised but have won general acceptance. However, the bore and outside diameters conform to those of Diameter Series 0 for radial bearings according to ISO 15-1981.

Tolerances

SKF double direction angular contact thrust ball bearings meet the same high demands with respect to dimensional and running accuracy as the cylindrical roller bearings of series NN 30 K and N 10 K.

Bearings of series 2344(00) are produced as standard to tolerance class SP specifications, but may, to special

order, also be produced with class UP tolerances.

The high-speed bearings of the BTM design are produced to tolerance class P4C specifications.

The actual tolerance values for classes P4C, SP and UP will be found in **Tables 7 to 9** on **pages 72 and 73**.

Preload

SKF double direction angular contact thrust ball bearings are supplied with a preload as specified in **Tables 1** and **2**.

The values quoted in the table apply to bearings before mounting. When mounted, the bearings may have a higher preload, depending on the shaft tolerance selected.

Speed ratings

The speed ratings quoted in the bearing tables for BTM bearings apply to bearings with class A preload, where the load is light ($P \leq 0,06 C$) and heat transfer from the bearing position is good. The values quoted for oil spot lubrication are maximum ratings which must be reduced for other methods of oil lubrication. For heavily loaded bearings with class B preload the values should be reduced; they should be multiplied with the factor 0,55.

Cages

SKF double direction angular contact thrust ball bearings are fitted with two ball centred cages. Depending on series and size, the cages may be either of machined brass or heat stabilised, glass fibre reinforced polyamide 6,6 (→ **fig 3**). Bearings of series 2344(00) fitted with polyamide cages are identified by the designation suffix TN or TN9. The BTM-design bearings are fitted exclusively with polyamide cages so that there is no extra TN or TN9 suffix in the designation.

Bearings with polyamide 6,6 cages can be used at operating temperatures up to +120 °C. The cage properties are not affected by the lubricants normally used for bearings with the exception of some synthetic oils and greases with a synthetic oil base.

Equivalent dynamic bearing load

For double direction angular contact

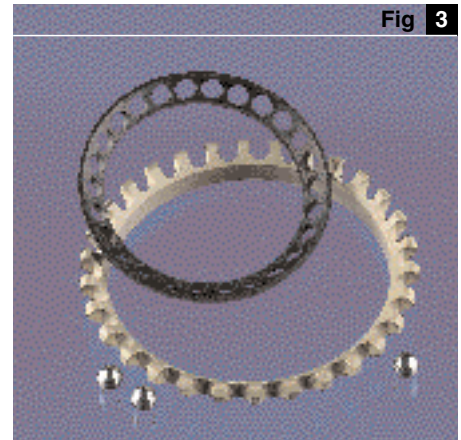

Cages for double direction angular contact thrust ball bearings

thrust ball bearings subjected to axial load only

$$P = F_a$$

Equivalent static bearing load

For double direction angular contact thrust ball bearings subjected to axial load only

$$P_0 = F_a$$

Mounting instructions

When mounting double direction angular contact thrust ball bearings care should be taken not to mix the components of one bearing with those of other bearings. When mounting bearings of series 2344(00) care should also be taken not to apply too much axial force as otherwise the spacer sleeve may be deformed and excessive axial preload may result which would cause a rise in running temperature and would shorten bearing life. Suitable values for the axial force (in Newton) to be applied lie between 80 and $200 \times d$ (d = bearing bore diameter in mm).

Table 1

Bore diameter	Axial pre-load	Bore diameter	Axial pre-load
mm	N	mm	N
40	360	100	690
45	390	105	710
50	415	110	735
55	440	120	800
60	470	130	870
65	490	140	940
70	515	150	1 015
75	545	160	1 100
80	575	170	1 185
85	600	180	1 290
90	625	190	1 385
95	655	200	1 525

Axial preload in double direction angular contact thrust ball bearings, series 2344(00)

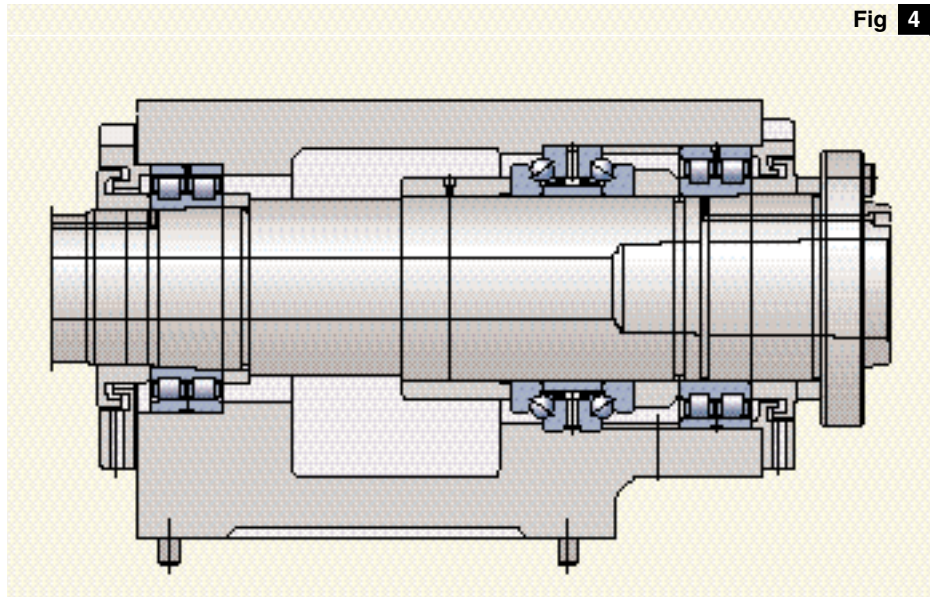

Fig 4

SKF spindle unit of the MSUP design with standard bearing arrangement
Two double row cylindrical roller bearings of series NN 30 K and one double direction angular contact thrust ball bearing of series 2344(00)

Table 2

Bore diameter	Axial preload		BTM .. B	
	BTM .. A		Preload class	
	DBA	DBB	DBA	DBB
mm	N		N	
80	300	750	400	1 200
90	400	1 000	550	1 450
100	400	1 000	550	1 650
120	600	1 500	850	2 450
130	800	1 900	1 050	3 000

Axial preload in double direction angular contact thrust ball bearings, series BTM .. A and BTM .. B

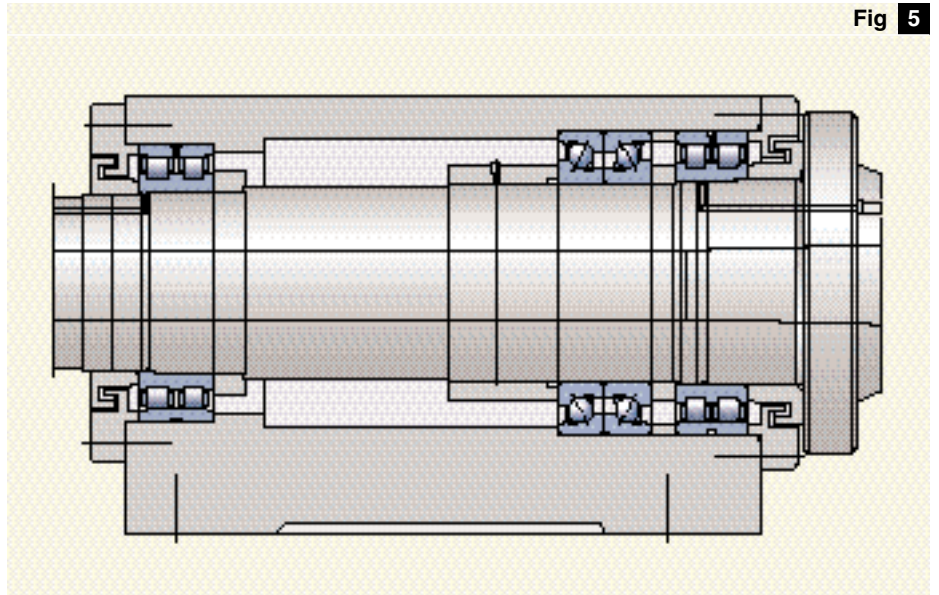
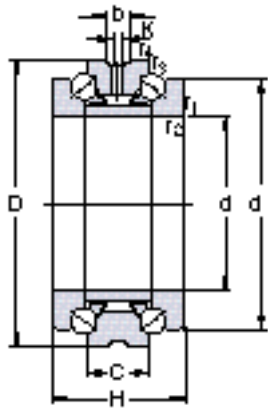

Fig 5

Classic spindle bearing arrangement with two double row cylindrical roller bearings of series NN 30 K and one double direction angular contact thrust ball bearing of the BTM design for high machining performance

Angular contact thrust ball bearings, double direction

d 40 – 170 mm



2344(00)

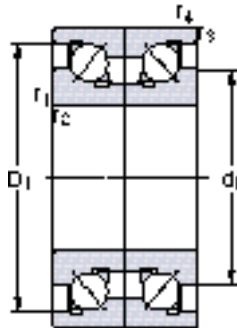

BTM .. B

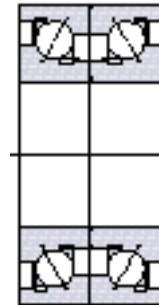

BTM .. A

Principal dimensions			Basic load ratings		Fatigue load limit P_u	Speed ratings		Mass	Designation
d	D	H	dynamic	static		Lubrication	oil spot		
mm			C	C_0	N	r/min	grease	kg	–
40	68	36	21 600	60 000	2 240	9 500	12 000	0,46	234408 BM1
45	75	38	24 700	71 000	2 600	9 000	11 000	0,58	234409 BM1
50	80	38	25 500	78 000	2 850	8 500	10 000	0,62	234410 BM1
55	90	44	33 800	104 000	3 800	7 000	8 500	0,94	234411 BM1
60	95	44	34 500	108 000	4 000	7 000	8 500	1,00	234412 TN9
65	100	44	35 800	116 000	4 300	6 700	8 000	1,05	234413 TN9
70	110	48	43 600	143 000	5 300	6 300	7500	1,45	234414 TN9
75	115	48	44 200	150 000	5 600	6 000	7 000	1,55	234415 BM1
80	125	40,5	41 500	104 000	3 900	7 000	9 000	1,60	BTM 80 A/DBA
	125	40,5	49 000	120 000	4 400	6 300	8 000	1,60	BTM 80 B/DBA
	125	54	54 000	180 000	6 550	5 300	6 300	2,10	234416 TN9
85	130	54	54 000	190 000	6 700	5 300	6 300	2,20	234417 TN9
90	140	45	49 000	125 000	4 470	6 300	8 000	2,30	BTM 90 A/DBA
	140	45	57 000	143 000	5 100	5 600	7 000	2,30	BTM 90 B/DBA
	140	60	62 400	220 000	7 650	4 800	5 600	3,00	234418 TN9
95	145	60	63 700	232 000	7 800	4 800	5 600	3,05	234419 BM1
100	150	45	51 000	140 000	4 740	6 000	7 500	2,40	BTM 100 A/DBA
	150	45	61 000	163 000	5 400	5 300	6 700	2,40	BTM 100 B/DBA
	150	60	66 300	245 000	8 150	4 800	5 600	3,15	234420 TN9
105	160	66	74 100	275 000	8 800	4 300	5 000	4,05	234421 BM1
110	170	72	92 300	335 000	10 400	4 000	4 800	5,05	234422 BM1
120	180	54	73 500	212 000	6 500	4 800	6 000	4,35	BTM 120 A/DBA
	180	54	86 500	240 000	7 200	4 300	5 300	4,35	BTM 120 B/DBA
	180	72	93 600	360 000	10 800	3 800	4 500	5,70	234424 TN9
130	200	63	90 000	265 000	7 700	4 500	5 600	6,25	BTM 130 A/DBA
	200	63	108 000	300 000	8 800	3 800	4 800	6,25	BTM 130 B/DBA
	200	84	117 000	455 000	13 200	3 400	4 000	8,15	234426 TN9
140	210	84	117 000	475 000	13 200	3 200	3 800	8,65	234428 BM1
150	225	90	140 000	570 000	15 300	3 000	3 600	10,5	234430 BM1
160	240	96	156 000	640 000	16 600	2 800	3 400	14,0	234432 BM1
170	260	108	195 000	780 000	19 600	2 400	3 000	17,5	234434 BM1

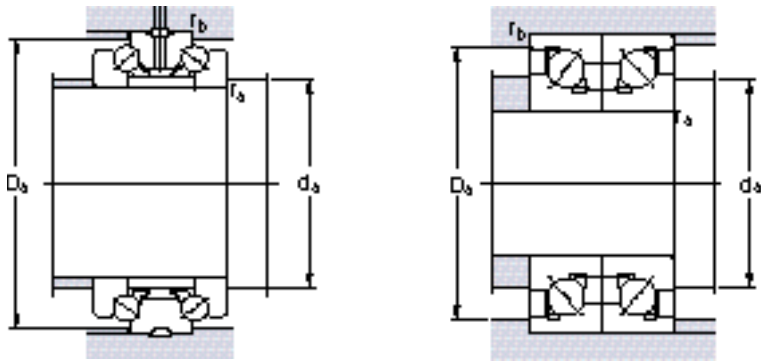

Dimensions

Abutment and fillet dimensions

d	d ₁ ≈	C, D ₁	K	b	r _{1,2} min	r _{3,4} min	d _a min	D _a min	r _a max	r _b max
mm							mm			
40	58,5	18	3	5,5	1	0,15	50	64	1	0,1
45	65	19	3	5,5	1	0,15	56	71	1	0,1
50	70	19	3	5,5	1	0,15	61	76	1	0,1
55	78	22	3	5,5	1,1	0,3	68	85	1	0,3
60	83	22	3	5,5	1,1	0,3	73	90	1	0,3
65	88	22	3	5,5	1,1	0,3	78	95	1	0,3
70	97	24	3	5,5	1,1	0,3	85	105	1	0,3
75	102	24	3	5,5	1,1	0,3	90	110	1	0,3
80	100	115	–	–	1,1	0,6	89	117	1	0,6
	100	115	–	–	1,1	0,6	89	117	1	0,6
	110	27	4,5	8,3	1,1	0,3	97	119	1	0,3
85	115	27	4,5	8,3	1,1	0,3	102	124	1	0,3
90	113	129	–	–	1,5	0,6	101	131	1,5	0,6
	113	129	–	–	1,5	0,6	101	131	1,5	0,6
	123	30	4,5	8,3	1,5	0,3	109	132	1,5	0,3
95	128	30	4,5	8,3	1,5	0,3	114	137	1,5	0,3
100	123	139	–	–	1,5	0,6	107	141	1,5	0,6
	123	139	–	–	1,5	0,6	107	141	1,5	0,6
	133	30	4,5	8,3	1,5	0,3	119	142	1,5	0,3
105	142	33	4,5	8,3	2	0,6	125	151	2	0,6
110	150	36	4,5	8,3	2	0,6	132	161	2	0,6
120	147	167	–	–	2	1	128	169	2	1
	147	167	–	–	2	1	128	169	2	1
	160	36	4,5	8,3	2	0,6	142	171	2	0,6
130	162	183	–	–	2	1	143	188	1,5	1
	162	183	–	–	2	1	143	188	1,5	1
	177	42	6	11,1	2	0,6	156	190	2	0,6
140	187	42	6	11,1	2,1	0,6	166	200	2	0,6
150	200	45	7,5	13,9	2,1	0,6	178	213	2	0,6
160	212	48	7,5	13,9	2,1	0,6	190	227	2	0,6
170	230	54	7,5	13,9	2,1	0,6	204	246	2	0,6

Angular contact thrust ball bearings, double direction
d 180 – 200 mm

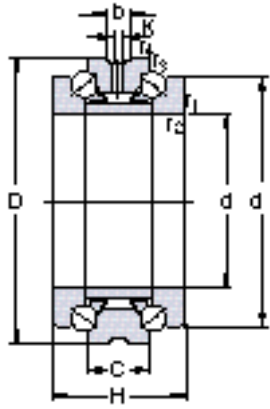

1

Principal dimensions			Basic load ratings		Fatigue load limit P_u	Speed ratings		Mass	Designation
d	D	H	dynamic	static		Lubrication	grease		
mm			N		N	r/min		kg	–
180	280	120	225 000	915 000	22 400	2 000	2 600	23,0	234436 BM1
190	290	120	225 000	950 000	22 800	2 000	2 600	24,0	234438 BM1
200	310	132	265 000	1 100 000	25 500	1 900	2 400	31,0	234440 BM1

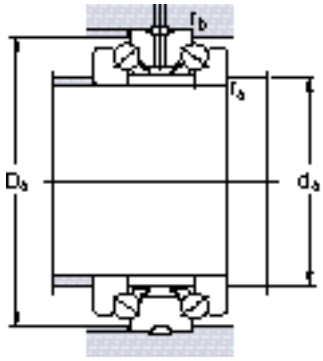

Dimensions

Abutment and fillet dimensions

d	d ₁ ≈	C	K	b	r _{1,2} min	r _{3,4} min	d _a min	D _a min	r _a max	r _b max
mm							mm			
180	248	60	9	16,7	2,1	0,6	214	264	2	0,6
190	258	60	9	16,7	2,1	0,6	224	274	2	0,6
200	274	66	9	16,7	2,1	0,6	236	292	2	0,6

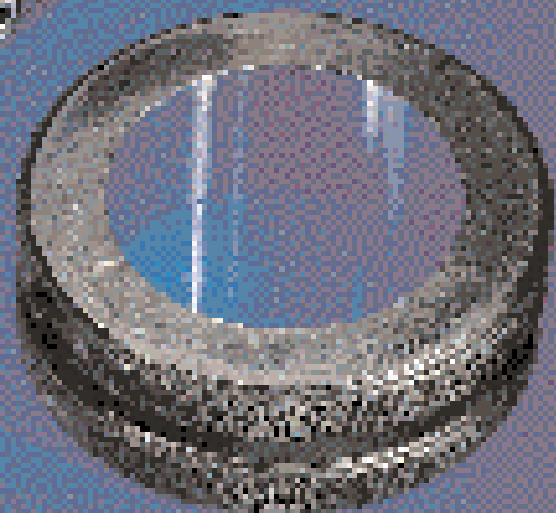

Gauges

Conventional measuring methods and instruments are not entirely satisfactory for checking tapered journals or the radial internal clearance of cylindrical roller bearings. SKF has therefore developed a range of gauges especially to suit the requirements of rolling bearing applications, although they are equally useful for other applications.

Ring gauges

SKF GRA 30 ring gauges are practical aids for checking the tapered shaft seatings for bearings of series NN 30 K, which are commonly used for machine tool applications. The gauges can also be used to check the shaft seatings for bearings of series N 10 K as well as those for series NNU 49 K; the width of the latter series differs only slightly from that of series NN 30 K.

SKF ring gauges are available for tapered seatings having diameters up to and including 200 mm (→ **Product table on page 64**).

The gauging or reference face of ring gauges of series GRA 30 is at the large end of the bore and is used to determine the position of the tapered seating relative to a reference surface on the shaft. This reference surface may be either in front of, or behind the gauging face of the ring gauge. Where there is a free choice of dimensions it should be remembered that the reference length B_c should always be longer than the dimension B_b , the width of the intermediate ring, by an amount corresponding to the difference $B_c - B_b$, as the bearing will be driven up further

on the seating than the ring gauge when the bearing is being mounted. The final value of dimension B_b is determined during mounting, taking into account the desired bearing radial internal clearance.

Ring gauges can also be used to check whether the reference surface of the shaft shoulder is at right angles to the centreline of the tapered seating, as well as for checking the position and diameter of the seating. This is done by measuring the distance between the gauging surface of the ring gauge and the reference surface of the shaft using end measures. Errors of form of the taper are checked using marking blue.

Internal clearance gauges

SKF gauges of series GB 30 are available for use with double row cylindrical roller bearings NN 3006 K to NN 3040 K, inclusive. They may also be used for the single row cylindrical roller bearings of series N 10 K.

SKF GB gauges are made in two different designs depending on size.

The one design is that of gauges GB 3006 to GB 3020, inclusive. These can be used to measure the circumscribed diameter, i.e. the diameter over the rollers when they are in contact with the inner ring raceway, to an accuracy of 1 μm . The larger gauges GB 3021 to GB 3040, inclusive, have a measuring accuracy of 2 μm . The body of the gauges up to and including GB 3020 is in two parts, that of the larger gauges is slotted.

The body of the gauges has two diametrically opposed gauging zones which are ground on its bore diameter surface. The body can be expanded by means of an adjustable screw. This enables the gauge to be pushed over the inner ring with roller and cage assembly without damaging the rollers and gauging surfaces. The measuring ring which is screwed to one half of the gauging ring transmits the diameter measured by both halves of the gauging ring to the indicator dial.

Measuring

Using a bore gauge, the raceway of the mounted outer ring is measured, and the recorded dimension transferred to the centres of the gauging zones, taking into consideration the desired radial internal clearance or preload. The indicator of the GB 30 gauge is then set to zero. The inner ring with roller and cage assembly is pushed up on to its tapered journal and driven up until the indicator of the pre-set gauge again shows zero when the gauge is placed in position around the bearing set.

Ring gauges, series GRA 30

d 25 – 200 mm

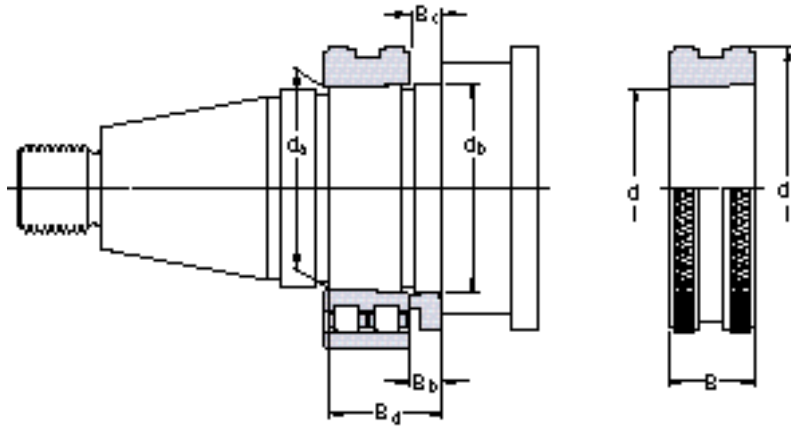

тапет 1. 12

Bearing Designation	Bearing seating Dimensions						Ring gauge Dimensions			Mass	Designation
	d _a	d _b	B _b	B _c Nominal	Tolerance	B _d	d	d ₁	B		
–	mm						mm			kg	–
NN 3005 K	25,10	27	4	4,2	±0,1	19	25	46	16	0,13	GRA 3005
NN 3006 K	30,10	32	6	6,2	±0,1	24	30	52	19	0,18	GRA 3006
NN 3007 K	35,10	37	6	6,2	±0,1	25	35	57	20	0,21	GRA 3007
NN 3008 K	40,10	42	8	8,2	±0,1	28	40	62	21	0,26	GRA 3008
NN 3009 K	45,10	47	8	8,2	±0,1	30	45	67	23	0,31	GRA 3009
NN 3010 K	50,10	52	8	8,2	±0,1	30	50	72	23	0,34	GRA 3010
NN 3011 K	55,15	57	8	8,3	±0,12	32,5	55	77	26	0,42	GRA 3011
NN 3012 K	60,15	62	10	10,3	±0,12	34,5	60	82	26	0,45	GRA 3012
NN 3013 K	65,15	67	10	10,3	±0,12	34,5	65	88	26	0,51	GRA 3013
NN 3014 K	70,15	73	10	10,3	±0,12	38,5	70	95	30	0,69	GRA 3014
NN 3015 K	75,15	78	10	10,3	±0,12	38,5	75	100	30	0,73	GRA 3015
NN 3016 K	80,15	83	12	12,3	±0,12	44,5	80	105	34	0,88	GRA 3016
NN 3017 K	85,20	88	12	12,4	±0,15	44	85	112	34	1,00	GRA 3017
NN 3018 K	90,20	93	12	12,4	±0,15	47	90	120	37	1,30	GRA 3018
NN 3019 K	95,20	98	12	12,4	±0,15	47	95	128	37	1,55	GRA 3019
NN 3020 K	100,20	103	12	12,4	±0,15	47	100	135	37	1,70	GRA 3020
NN 3021 K	105,20	109	12	12,4	±0,15	51	105	142	41	2,10	GRA 3021
NN 3022 K	110,25	114	12	12,5	±0,15	54,5	110	150	45	2,60	GRA 3022
NN 3024 K	120,25	124	15	15,5	±0,15	58,5	120	162	46	3,05	GRA 3024
NN 3026 K	130,25	135	15	15,5	±0,15	64,5	130	175	52	3,95	GRA 3026
NN 3028 K	140,30	145	15	15,6	±0,15	65	140	188	53	4,75	GRA 3028
NN 3030 K	150,30	155	15	15,6	±0,15	68	150	200	56	5,60	GRA 3030
NN 3032 K	160,30	165	15	15,6	±0,15	72	160	215	60	6,80	GRA 3032
NN 3034 K	170,30	176	15	15,6	±0,15	79	170	230	67	8,80	GRA 3034
NN 3036 K	180,35	187	20	20,7	±0,15	90,5	180	245	74	11,5	GRA 3036
NN 3038 K	190,35	197	20	20,7	±0,18	91,5	190	260	75	13,0	GRA 3038
NN 3040 K	200,35	207	20	20,7	±0,18	98,5	200	270	82	15,0	GRA 3040

Internal clearance gauges, series GB 30

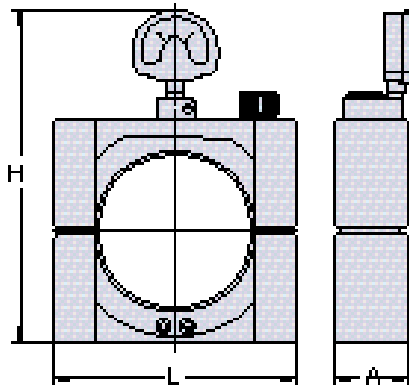

GB 3006 – GB 3020

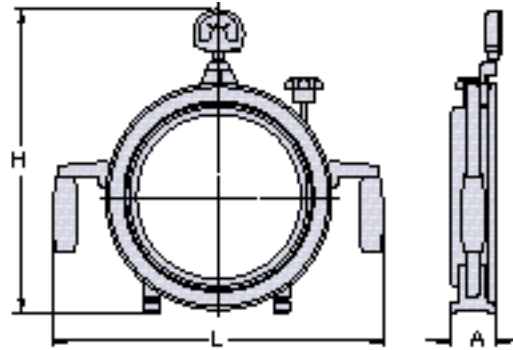

GB 3021 – GB 3040

Bearing Designation	Internal clearance gauge Dimensions			Mass	Designation
	L	H	A		
–	mm			kg	–
NN 3006 K	107	175	36	2,00	GB 3006
NN 3007 K	112	180	37	2,00	GB 3007
NN 3008 K	117	185	39	2,00	GB 3008
NN 3009 K	129	197	40	2,50	GB 3009
NN 3010 K	134	202	40	2,50	GB 3010
NN 3011 K	144	212	43	3,50	GB 3011
NN 3012 K	152	222	44	4,00	GB 3012
NN 3013 K	157	225	44	4,00	GB 3013
NN 3014 K	164	232	48	5,00	GB 3014
NN 3015 K	168	236	48	5,00	GB 3015
NN 3016 K	176	244	52	6,00	GB 3016
NN 3017 K	185	253	53	6,50	GB 3017
NN 3018 K	198	266	56	8,00	GB 3018
NN 3019 K	203	271	56	9,00	GB 3019
NN 3020 K	212	280	56	9,00	GB 3020
NN 3021 K	322	350	46	10,5	GB 3021
NN 3022 K	332	362	46	11,0	GB 3022
NN 3024 K	342	376	48	12,0	GB 3024
NN 3026 K	364	396	54	13,0	GB 3026
NN 3028 K	378	410	54	14,5	GB 3028
NN 3030 K	391	426	58	15,0	GB 3030
NN 3032 K	414	446	60	16,0	GB 3032
NN 3034 K	430	464	62	17,0	GB 3034
NN 3036 K	454	490	70	17,5	GB 3036
NN 3038 K	468	504	70	18,0	GB 3038
NN 3040 K	488	520	74	19,0	GB 3040

Tolerances

The dimensional and running accuracy of rolling bearings has been standardised internationally. In addition to the Normal tolerances which are adequate for the majority of bearing applications, the ISO standards cover closer tolerances, e.g. tolerance classes 6 and 5. For precision bearings, which are primarily used for machine tool spindles of all types, even greater accuracy is required.

SKF precision bearings are therefore produced to the following tolerance class specifications, depending on the type of bearing and the most usual applications. The actual values are given in **Tables 1** to **9**. The tolerance classes are as follows.

- P4A and PA9A for radial angular contact ball bearings
- SP and UP for radial cylindrical roller bearings
- P4/P2 for single direction angular contact thrust ball bearings
- P4C for double direction angular contact thrust ball bearings of the BTM design
- SP and UP for double direction angular contact thrust ball bearings of series 2344(00)

The actual values correspond, or are closer than those specified in

- DIN 620-2:1988 and DIN 620-3:1982
- ISO 492:1994 and ISO 199:1979
- ANSI/AFBMA Standard 20-1987

The tolerance symbols used in the tolerance tables are explained in the following.

d	nominal bore diameter	B_{1s}, C_{1s}	single width of inner ring and outer ring, respectively, of a bearing specially manufactured for paired mounting
d_{mp}	mean bore diameter; arithmetical mean of the largest and smallest single bore diameters in one plane	Δ_{Bs}, Δ_{Cs}	deviation of single inner ring width or single outer ring width from the nominal
d_s	single bore diameter	Δ_{B1s}, Δ_{C1s}	deviation of single inner ring width or single outer ring width from the nominal of a bearing specially manufactured for paired mounting
Δ_{dmp}	deviation of the mean bore diameter from the nominal	V_{Bs}, V_{Cs}	ring width variation; difference between the largest and smallest single widths of inner ring and of outer ring, respectively
Δ_{d2mp}	deviation of the mean bore diameter at the theoretical small end of a tapered bore from the nominal	Δ_{Ts}	deviation of single height of thrust bearing from the nominal
Δ_{d3mp}	deviation of the mean bore diameter at the theoretical large end of a tapered bore from the nominal	K_{ia}, K_{ea}	radial runout of assembled bearing inner ring and assembled bearing outer ring, respectively
Δ_{ds}	deviation of a single bore diameter from the nominal	S_d	side face runout with reference to bore (of inner ring)
V_{dp}	bore diameter variation; difference between the largest and smallest single bore diameters in one plane	S_D	outside inclination variation; variation in inclination of outside cylindrical surface to outer ring side face
V_{dmp}	mean bore diameter variation; difference between the largest and smallest single bore diameters in one plane	S_{ia}, S_{ea}	side face runout of assembled bearing inner ring and assembled bearing outer ring, respectively
D	nominal outside diameter	S_i, S_e	thickness variation, measured from middle of raceway to back (seating) face of shaft washer and of housing washer, respectively (axial runout)
D_{mp}	mean outside diameter; arithmetical mean of the largest and smallest single outside diameters in one plane		
D_s	single outside diameter		
Δ_{Dmp}	deviation of the mean outside diameter from the nominal		
Δ_{Ds}	deviation of a single outside diameter from the nominal		
V_{Dp}	outside diameter variation; difference between the largest and smallest single outside diameters in one plane		
V_{Dmp}	mean outside diameter variation; difference between the largest and smallest mean bore diameters of one ring or washer		
B_s, C_s	single width of inner ring and outer ring, respectively		

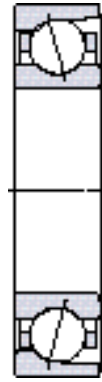

Class P4A tolerances for radial angular contact ball bearings

Table 1

Inner ring		Δ_{dmp}		Δ_{ds}		V_{dp}	V_{dmp}	Δ_{Bs}		Δ_{B1s}		V_{Bs}	K_{ia}	S_d	S_{ia}
over	incl.	high	low	high	low	max	max	high	low	high	low	max	max	max	max
mm		μm		μm		μm	μm	μm				μm	μm	μm	μm
2,5	10	0	-4	0	-4	1,3	1	0	-40	0	-250	1,3	1,3	1,3	1,3
10	18	0	-4	0	-4	1,3	1	0	-80	0	-250	1,3	1,3	1,3	1,3
18	30	0	-5	0	-5	1,3	1	0	-120	0	-250	1,3	2,5	1,3	2,5
30	50	0	-6	0	-6	1,3	1	0	-120	0	-250	1,3	2,5	1,3	2,5
50	80	0	-7	0	-7	2	1,3	0	-150	0	-250	1,3	2,5	1,3	2,5
80	120	0	-8	0	-8	2,5	1,5	0	-200	0	-250	2,5	2,5	2,5	2,5
120	150	0	-10	0	-10	6	3	0	-250	0	-380	4	4	4	4
150	180	0	-10	0	-10	6	3	0	-250	0	-380	4	6	5	6
180	250	0	-12	0	-12	7	4	0	-300	0	-500	5	7	6	7

Outer ring		Δ_{Dmp}		Δ_{Ds}		V_{Dp}	V_{Dmp}	$\Delta_{Cs}, \Delta_{C1s}$		V_{Cs}	K_{ea}	S_D	S_{ea}
over	incl.	high	low	high	low	max	max			max	max	max	max
mm		μm		μm		μm	μm			μm	μm	μm	μm
18	30	0	-5	0	-5	2	1,3	Values are identical to those of inner ring of same bearing		1,3	2,5	1,3	2,5
30	50	0	-6	0	-6	2	1,3			1,3	2,5	1,3	2,5
50	80	0	-7	0	-7	2	1,3			1,3	3,8	1,3	3,8
80	120	0	-8	0	-8	2,5	1,3			2,5	5	2,5	5
120	150	0	-9	0	-9	2,5	1,5			2,5	5	2,5	5
150	180	0	-10	0	-10	6	3			4	6	4	6
180	250	0	-11	0	-11	6	4			5	8	5	8
250	315	0	-13	0	-13	8	5			5	9	6	8
315	400	0	-15	0	-15	9	6			7	10	8	10



Class PA9A tolerances for radial angular contact ball bearings

Table 2

Inner ring													
d		Δ_{ds}		V_{dp}	V_{dmp}	Δ_{Bs}		Δ_{B1s}		V_{Bs}	K_{ia}	S_d	S_{ia}
over	incl.	high	low	max	max	high	low	high	low	max	max	max	max
mm		μm		μm	μm	μm		μm		μm	μm	μm	μm
2,5	10	0	-2,5	1,3	1	0	-25	0	-250	1,3	1,3	1,3	1,3
10	18	0	-2,5	1,3	1	0	-80	0	-250	1,3	1,3	1,3	1,3
18	30	0	-2,5	1,3	1	0	-120	0	-250	1,3	2,5	1,3	2,5
30	50	0	-2,5	1,3	1	0	-120	0	-250	1,3	2,5	1,3	2,5
50	80	0	-3,8	2	1,3	0	-150	0	-250	1,3	2,5	1,3	2,5
80	120	0	-5	2,5	1,5	0	-200	0	-380	2,5	2,5	2,5	2,5
120	150	0	-6,5	3	2	0	-250	0	-380	2,5	2,5	2,5	2,5
150	180	0	-6,5	3	2	0	-300	0	-500	3,8	5	3,8	5
180	250	0	-7,5	4	2,5	0	-350	0	-500	3,8	5	3,8	5

Outer ring											
D		Δ_{Ds}		V_{Dp}	V_{Dmp}	$\Delta_{Cs}, \Delta_{C1s}$		V_{Cs}	K_{ea}	S_D	S_{ea}
over	incl.	high	low	max	max			max	max	max	max
mm		μm		μm	μm			μm	μm	μm	μm
18	30	0	-3,8	2	1,3	Values are identical inner ring of same bearing		1,3	2,5	1,3	2,5
30	50	0	-3,8	2	1,3			1,3	2,5	1,3	2,5
50	80	0	-3,8	2	1,3			1,3	3,8	1,3	3,8
80	120	0	-5	2,5	1,3			2,5	5	2,5	5
120	150	0	-5	2,5	1,5			2,5	5	2,5	5
150	180	0	-6,5	3	2			2,5	5	2,5	5
180	250	0	-7,5	4	2,5			3,8	6,5	3,8	6,5
250	315	0	-7,5	4	3,5			3,8	6,5	3,8	6,5
315	400	0	-10	5	5			6,5	7,5	6,5	7,5

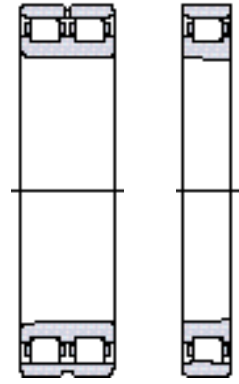

Class SP tolerances for cylindrical roller bearings

Table 3

Inner ring									
d		$\Delta_{ds}^{1)}$		V_{dp}	Δ_{Bs}		V_{Bs}	K_{ia}	S_d
over	incl.	high	low	max	high	low	max	max	max
mm		μm		μm	μm		μm	μm	μm
–	18	0	–5	3	0	–100	5	3	8
18	30	0	–6	3	0	–100	5	3	8
30	50	0	–8	4	0	–120	5	4	8
50	80	0	–9	5	0	–150	6	4	8
80	120	0	–10	5	0	–200	7	5	9
120	180	0	–13	7	0	–250	8	6	10
180	250	0	–15	8	0	–300	10	8	11
250	315	0	–18	9	0	–350	13	10	13
315	400	0	–23	12	0	–400	15	12	15

¹⁾ SP tolerances for tapered bore (taper 1:12) see Table 5

Outer ring									
D		Δ_{Ds}		V_{Dp}	Δ_{Cs}, V_{Cs}		K_{ea}	S_D	
over	incl	high	low	max			max	max	
mm		μm		μm			μm	μm	
30	50	0	–7	4	Values are identical to those of inner ring of same bearing		5	8	
50	80	0	–9	5			5	8	
80	120	0	–10	5			6	9	
120	150	0	–11	6			7	10	
150	180	0	–13	7			8	10	
180	250	0	–15	8			10	11	
250	315	0	–18	9			11	13	
315	400	0	–20	10			13	13	
400	500	0	–23	12			15	15	

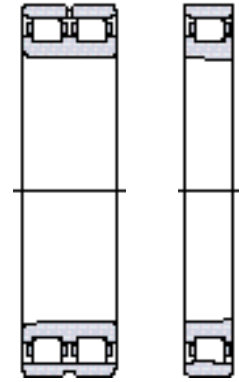

Class UP tolerances for cylindrical roller bearings

Table 4

Inner ring									
d		$\Delta_{ds}^{1)}$		V_{dp}	Δ_{Bs}		V_{Bs}	K_{ia}	S_d
over	incl.	high	low	max	high	low	max	max	max
mm		μm		μm	μm		μm	μm	μm
–	18	0	–4	2	0	–25	1,5	1,5	2
18	30	0	–5	2,5	0	–25	1,5	1,5	3
30	50	0	–6	3	0	–30	2	2	3
50	80	0	–7	3,5	0	–40	3	2	4
80	120	0	–8	4	0	–50	3	3	4
120	180	0	–10	5	0	–60	4	3	5
180	250	0	–12	6	0	–75	5	4	6
250	315	0	–18	9	0	–90	6	5	6
315	400	0	–23	12	0	–100	8	6	6

¹⁾ SP tolerances for tapered bore (taper 1:12) see Table 5.

Outer ring									
D		Δ_{Ds}		V_{Dp}	Δ_{Cs}, V_{Cs}		K_{ea}	S_D	
over	incl.	high	low	max			max	max	
mm		μm		μm			μm	μm	
30	50	0	–5	3	Values are identical to those of inner ring of same bearing		3	2	
50	80	0	–6	3			3	2	
80	120	0	–7	4			3	3	
120	150	0	–8	4			4	3	
150	180	0	–9	5			4	3	
180	250	0	–10	5			5	4	
250	315	0	–12	6			6	4	
315	400	0	–14	7			7	5	
400	500	0	–17	9			8	5	

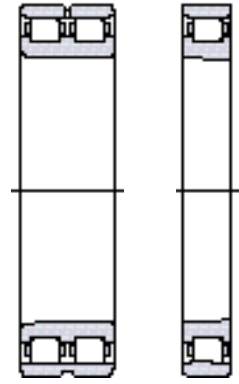

Class SP and UP tolerances for tapered bore, taper 1:12

Table 5

d		Tolerance class SP					Tolerance class UP				
		Δ_{d2mp}		V_{dp}	$\Delta_{d3mp} - \Delta_{d2mp}^{1)}$		Δ_{d2mp}		V_{dp}	$\Delta_{d3mp} - \Delta_{d2mp}^{1)}$	
over	incl.	high	low	max	high	low	high	low	max	high	low
mm		μm		μm	μm		μm		μm	μm	
18	30	+10	0	3	+4	0	+6	0	2,5	+2	0
30	50	+12	0	4	+4	0	+7	0	3	+3	0
50	80	+15	0	5	+5	0	+8	0	3,5	+3	0
80	120	+20	0	5	+6	0	+10	0	4	+4	0
120	180	+25	0	7	+8	0	+12	0	5	+4	0
180	250	+30	0	8	+10	0	+14	0	6	+5	0
250	315	+35	0	9	+12	0	+15	0	8	+6	0

¹⁾ $\Delta_{d3mp} - \Delta_{d2mp}$ = angular deviation over measuring length m

6

Measuring distance a			
Chamfer dimension $r_{s \text{ min}}$	Bearing bore d		Measuring distance a
	over	incl.	
mm	mm		mm
0,6	-	-	2,5
1	-	-	3,5
1,1	-	120	4
	120	-	5
1,5	-	120	5
	120	-	6
2	-	80	5,5
	80	220	6
	220	-	7
2,1	-	280	7,5
	280	-	8,5
2,5	-	280	7,5
	280	-	8,5
3	-	-	9,5

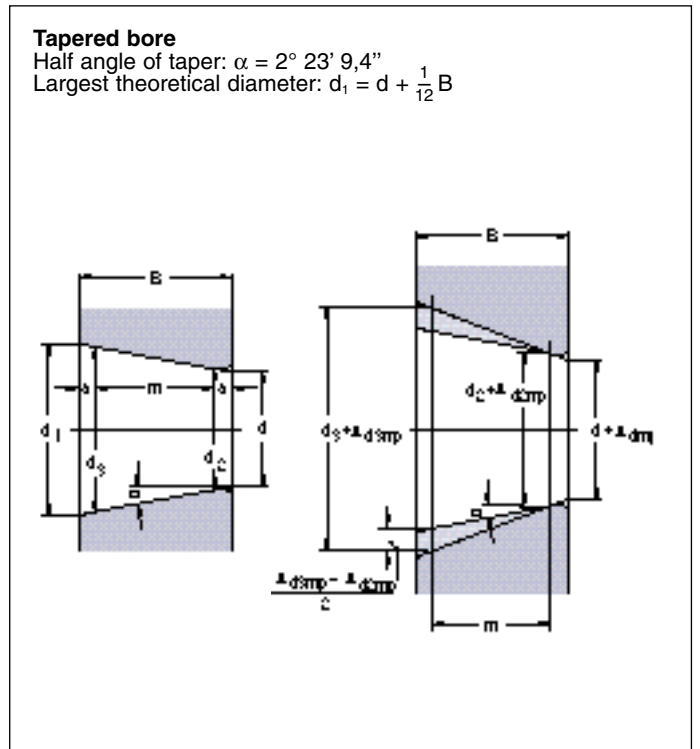

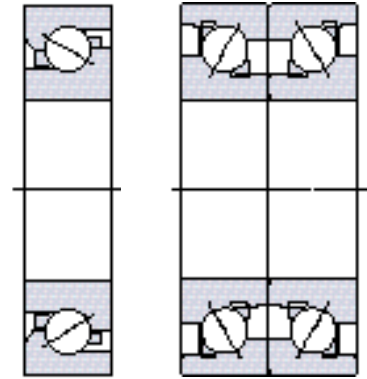

Class P4/P2 tolerances for single direction angular contact thrust ball bearings

Table 6

Shaft washer, housing washer and bearing height								
d, D		Δ_{ds}		Δ_{Ds}		Δ_{Ts}		S_i, S_e
over	incl.	high	low	high	low	high	low	max
mm		μm		μm		μm		μm
10	18	0	-3,8	-	-	0	-80	1,5
18	30	0	-3,8	-	-	0	-120	2,5
30	50	0	-5	0	-5	0	-120	2,5
50	80	0	-5	0	-5	0	-150	2,5
80	120	-	-	0	-7,5	0	-200	2,5

Class P4C tolerances for double direction angular contact thrust ball bearings, series BTM

Table 7

Shaft washer, housing washer and bearing height								
d, D		Δ_{ds}		Δ_{Ds}		Δ_{Cs}		S_i, S_e ¹⁾
over	incl.	high	low	high	low	high	low	max
mm		μm		μm		μm		μm
50	80	0	-7	-	-	0	-200	3
80	120	0	-8	-28	-38	0	-400	4
120	150	0	-10	-33	-44	0	-500	4
150	180	-	-	-33	-46	-	-	-
180	250	-	-	-37	-42	-	-	-
250	315	-	-	-41	-59	-	-	-

¹⁾ The tolerance values quoted must be considered as approximate, as the raceway runout is measured in the direction of the ball load. When the bearing has been mounted, the axial runout is generally smaller than quoted in the table



Class SP tolerances for double direction angular contact thrust ball bearings, series 2344(00)

Table 8

Shaft washer and bearing height						
d		Δ_{ds}		$S_i^{1)}$	Δ_{Ts}	
over	incl.	high	low	max	high	low
mm		μm		μm	μm	
18	30	+1	-9	3	+50	-80
30	50	+1	-11	3	+60	-100
50	80	+2	-14	4	+70	-120
80	120	+3	-18	4	+85	-140
120	180	+3	-21	5	+95	-160
180	250	+4	-26	5	+120	-200

¹⁾ The tolerance values quoted must be considered as approximate, as the raceway runout is measured in the direction of the ball load. When the bearing has been mounted, the axial runout is generally smaller than quoted in the table

Housing washer						
D		Δ_{Ds}		Δ_{Cs}		$S_{,,} S_e^{1)}$
over	incl.	high	low	high	low	
mm		μm		μm		
30	50	-20	-27	0	-60	Values are identical to those of shaft washer of same bearing
50	80	-24	-33	0	-60	
80	120	-28	-38	0	-60	
120	150	-33	-44	0	-60	
150	180	-33	-46	0	-60	
180	250	-37	-52	0	-60	
250	315	-41	-59	0	-60	

Class UP tolerances for double direction angular contact thrust ball bearings, series 2344(00)

Table 9

Shaft washer and bearing height						
d		Δ_{ds}		$S_i^{1)}$	Δ_{Ts}	
over	incl.	high	low	max	high	low
mm		μm		μm	μm	
18	30	0	-6	1,5	+50	-80
30	50	0	-8	1,5	+60	-100
50	80	0	-9	2	+70	-120
80	120	0	-10	2	+85	-140
120	180	0	-13	3	+95	-160
180	250	0	-15	3	+120	-200

¹⁾ The tolerance values quoted must be considered as approximate, as the raceway runout is measured in the direction of the ball load. When the bearing has been mounted, the axial runout is generally smaller than quoted in the table

Housing washer						
D		Δ_{Ds}		Δ_{Cs}		S_e
over	incl.	high	low	high	low	
mm		μm		μm		
30	50	-20	-27	0	-60	Values are identical to those of shaft washer of same bearing
50	80	-24	-33	0	-60	
80	120	-28	-38	0	-60	
120	150	-33	-44	0	-60	
150	180	-33	-46	0	-60	
180	250	-37	-52	0	-60	
250	315	-41	-59	0	-60	

The SKF group - a worldwide corporation

SKF is an international industrial Group operating in some 130 countries and is world leader in bearings.

The company was founded in 1907 following the invention of the self-aligning ball bearing by Sven Wingquist and, after only a few years, SKF began to expand all over the world.

Today, SKF has some 43 000 employees and more than 80 manufacturing facilities spread throughout the world. An international sales network includes a large number of sales companies and some 20 000 distributors and retailers. Worldwide availability of SKF products is supported by a comprehensive technical advisory service.

The key to success has been a consistent emphasis on maintaining the highest quality of its products and services. Continuous investment in research and

development has also played a vital role, resulting in many examples of epoch-making innovations.

The business of the Group consists of bearings, seals, special steel and a comprehensive range of other high-tech industrial components. The experience gained in these various fields provides SKF with the essential knowledge and expertise required in order to provide the customers with the most advanced engineering products and efficient service.

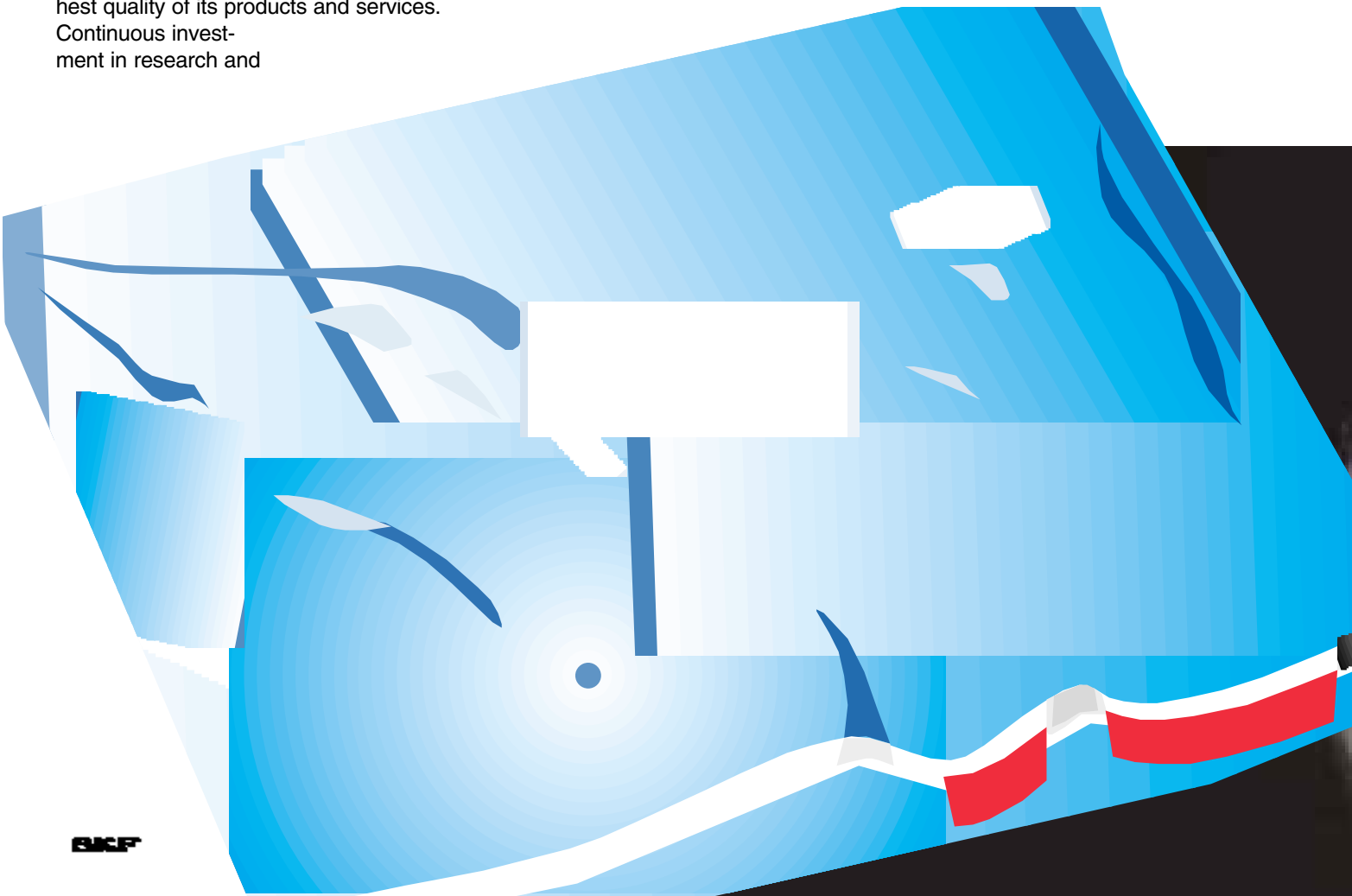



The SKF house colours are blue and red, but the thinking is green. The latest example is the factory in Malaysia, where the bearing component cleaning process conforms to the strictest ecological standards. Instead of trichloroethylene, a water-based cleaning fluid is used in a closed system. The cleaning fluid is recycled in the factory's own treatment plant.

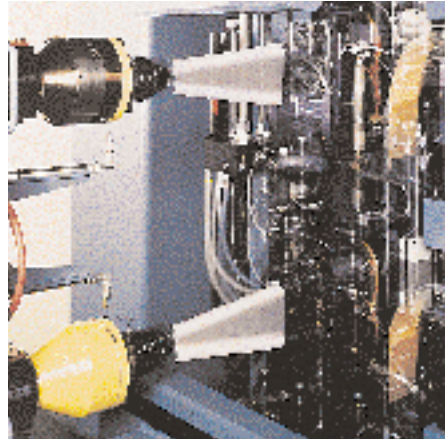

The SKF Engineering & Research Centre is situated just outside Utrecht in The Netherlands. In an area of 17 000 square metres (185 000 sq.ft) some 150 scientists, engineers and support staff are engaged in the further improvement of bearing performance. They are developing technologies aimed at achieving better materials, better designs, better lubricants and better seals – together leading to an even better understanding of the operation of a bearing in its application. This is also where the SKF Life Theory was evolved, enabling the design of bearings which are even more compact and offer even longer operational life.



SKF has developed the Channel concept in factories all over the world. This drastically reduces the lead time from raw material to end product as well as work in progress and finished goods in stock. The concept enables faster and smoother information flow, eliminates bottlenecks and bypasses unnecessary steps in production. The Channel team members have the knowledge and commitment needed to share the responsibility for fulfilling objectives in areas such as quality, delivery time, production flow etc.

SKF manufactures ball bearings, roller bearings and plain bearings. The smallest are just a few millimetres (a fraction of an inch) in diameter, the largest several metres. In order to protect the bearings effectively against the ingress of contamination and the escape of lubricant, SKF also manufactures oil and bearing seals. SKF's subsidiaries CR and RFT S.p.A. are among the world's largest producers of seals.

© Copyright SKF 1997

The data in this publication are based on current production. Redesign or more recent computer calculations have resulted in some changes. The basic dynamic and static load ratings have been calculated in accordance with the latest standards.

Earlier publications, in which the data deviate from those given here, are rendered invalid. The right is reserved to make changes necessitated by technological developments.

The contents of this publication are the copyright of the publisher and may not be reproduced (even extracts) unless permission is granted. Every care has been taken to ensure the accuracy of the information contained in this publication but no liability can be accepted for any loss or damage whether direct, indirect or consequential arising out of the use of the information contained herein.

Publication **4411 E**

Printed in Sweden on environmentally friendly, chlorine-free paper (Multiart Silk) by SG idé & tryck ab